

WKREŃTAKI AKUMULATOROWE



Przestawna rękojeść oraz ergonomiczny kształt wkrętaka umożliwia pracę nawet w trudnodostępnych miejscach.

Adjustable handle and ergonomic shape of the screwdriver allows operation even at hardly accessible places.

Регулируемая рукоятка и эргономичная форма шуруповерта позволяют работать даже в труднодоступных местах.



Automatyczne oświetlenie strefy pracy podczas wkręcania / wykręcania.

Automatic illumination of workspot during screwing and unscrewing.

Автоматическое освещение рабочей зоны во время работы.



Wbudowany system 5 diód LED umożliwia wykorzystywanie wkrętaka jako latarki.

In-built system of 5 LEDs allows to use the screwdriver as a flashlight.

Встроенная система диодной подсветки из 5 диодов LED позволяет использовать шурупверт в качестве фонарика.

- **Antypoślizgowa powierzchnia rękojeści zwiększa komfort pracy.**
Handle anti-slip surface improves work comfort.
- Антискользящая поверхность рукоятки повышает комфорт работы.
- **Zintegrowany magazynek na 8 końcówek wkrętakowych.**
Integrated clip for 8 driver bits.
- Интегрированный магазин, вмещающий 8 отверточных наконечников.



GRAPHITE

Wkrętarz akumulacyjny

Cordless Screwdriver • Akku-Schraubendreher • Шуруповерт аккумуляторный • Шрубоверт аккумуляторный • Akkumulátoros csavarozó • Surubelníř s akumulátor • Akumulátorový šroubovák • Akumulátorový skrutkovač • Akumulatorski vijčačnik • Akumulatorinis skruvėtuvas • Akumulatoras krūvgriezis • Akukurvikeeraja • Аккумуляторная отвертка • Akumulatorski odvijač • Akumulatorski odvijač • Επαναφορτιζόμενο κατσαβίδι • Destornillador a batería • Avvitatore a batteria • Chave de fenda de bateria • Tournevis à batteries

Ref. 58G144



4.8V

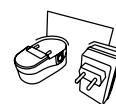

4.8V 230V~50Hz



170 min⁻¹



Ni-Cd



800 mAh



3 - 5h

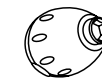

1/4" (6.35 mm)



0,47 kg

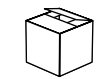

0/12

180mm

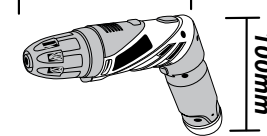

EAN 5902062581440

GRAPHITE

Wkrętarz akumulacyjny

Cordless Screwdriver • Akku-Schraubendreher • Шуруповерт аккумуляторный • Шрубоверт аккумуляторный • Akkumulátoros csavarozó • Surubelníř s akumulátor • Akumulátorový šroubovák • Akumulátorový skrutkovač • Akumulatorski vijčačnik • Akumulatorinis skruvėtuvas • Akumulatoras krūvgriezis • Akukurvikeeraja • Аккумуляторная отвертка • Akumulatorski odvijač • Akumulatorski odvijač • Επαναφορτιζόμενο κατσαβίδι • Destornillador a batería • Avvitatore a batteria • Chave de fenda de bateria • Tournevis à batteries

Ref. 58G147



4.8V

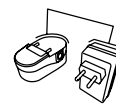

4.8V 230V~50Hz

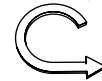

200 min⁻¹



Ni-Cd



800 mAh



3 - 5h

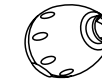

1/4" (6.35 mm)



0,56 kg



0/12

155 mm

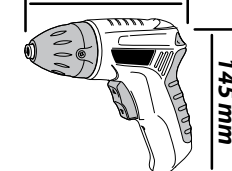

EAN 5902062581471

WIERTARKO-WKRĘTARKI AKUMULATORY



Antypoślizgowa powierzchnia rękojeści zwiększa komfort pracy.

Handle anti-slip surfaces improve work comfort.

Антискользящее покрытие рукоятки улучшает комфорт работы.



Magnetyczny uchwyt na akumulatorze przytrzymuje drobne elementy wkręty, bity.

Magnetic holder on the battery holds small items like screws, bits etc.

На аккумуляторе – магнитный держатель для мелких элементов (шурупов, наконечников).



Dioda LED do oświetlająca miejsce pracy.

LED illuminates your workspot.

Диод LED для освещения рабочего места.

- **Podwyższona pojemność akumulatora zwiększa wydajność pracy.**
- Enhanced battery capacity improves working efficiency.
- Повышенная емкость аккумулятора увеличивает производительность.
- **Precyzyjne wyważenie wkrętarki zwiększa komfort pracy szczególnie przy długotrwałej pracy.**
- Screwdriver is precisely balanced, which improves work comfort especially for long lasting work.
- Точная балансировка дрели-шуруповерта создает повышенный комфорт при длительной работе.
- **Elektryczny hamulec wrzeciona zapewnia precyzję wkręcania i wiercenia.**
- Electric spindle brake ensures screwing and drilling precision.
- Электрический тормоз шпинделя гарантирует точность ввинчивания и сверления.
- **Zintegrowany uchwyt w obudowie na dwustronne końcówki wkrętakowe.**
- Holder for double sided driver bits integrated in casing.
- В корпусе рукоятки – гнездо для крепления двухсторонних отверточных наконечников.
- **Dodatkowy akumulator zapobiega przerwom podczas pracy.**
- Additional battery prevents breaks in operation.
- Дополнительный аккумулятор позволяет избежать простоев в работе.



GRAPHITE

18V

15 17 19 21 23

Wiertarko-wkrętarca akumulatorowa

Cordless drill • Akkubohrschrauber • Аккумуляторная дрель-шуруповерт • Дрель-шуруповерт аккумуляторный • Akkumulátoros fúró-csavarbehajtó • Bormasina-surubelnita cu acumulator • Akumulátorová vrtáčka -šroubovák • Akumulátorový vrtací skrutkovač • Akumulatorski vrtalnik - vijačnik • Akumulatorinis gręžtuvas - suktuvas • Akumulatora urbmašina - skrūvgriezis • Akutrell • Пробивен винтоверт • Akumulatorska bušilica- izvijač • Akumulatorske bušilice - odvijača • Επαναφορτιζόμενο βραχίονο-κατσαβίδο • Taladro atornillador a batería • Trapano avvitavite senza filo • Aparafuradora de batería • Perceuse-visseuse à batterie

GRAPHITE



NEW

Ref. 58G111

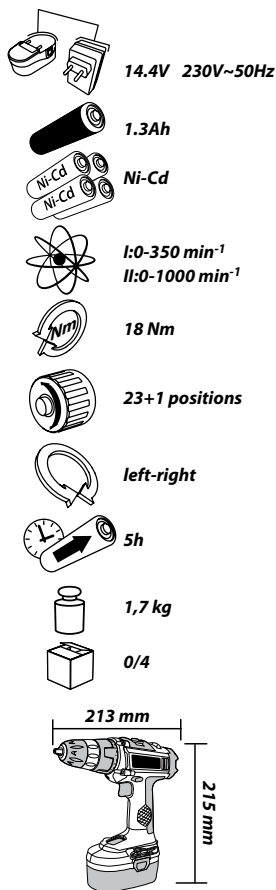

EAN 5902062581112



14,4V



Wiertarko-wkrętarca akumulatorowa

Cordless drill • Akkubohrschrauber • Аккумуляторная дрель-шуруповерт • Дрель-шуруповерт аккумуляторный • Akkumulátoros fúró-csavarbehajtó • Bormasina-surubelnita cu acumulator • Akumulátorová vrtáčka -šroubovák • Akumulátorový vrtací skrutkovač • Akumulatorski vrtalnik - vijačnik • Akumulatorinis gręžtuvas - suktuvas • Akumulatora urbmašina - skrūvgriezis • Akutrell • Пробивен винтоверт • Akumulatorska bušilica- izvijač • Akumulatorske bušilice - odvijača • Επαναφορτιζόμενο βραχίονο-κατσαβίδο • Taladro atornillador a batería • Trapano avvitavite senza filo • Aparafuradora de batería • Perceuse-visseuse à batterie

GRAPHITE



NEW

Ref. 58G116

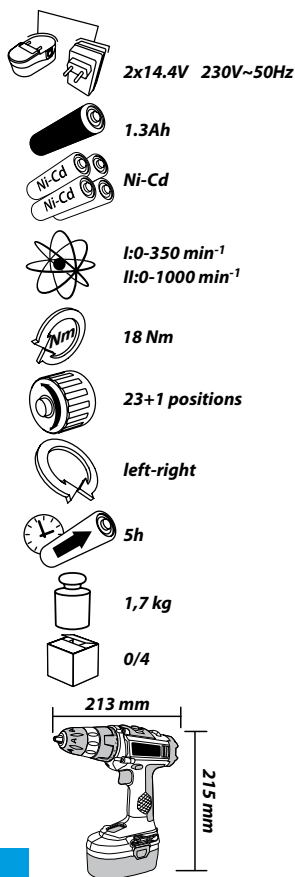

EAN 5902062581167



14,4V



GRAPHITE

Wiertarko-wkrętarka akumulatorowa
 Cordless drill • Akkubohrschrauber • Аккумуляторная дрель-шурупверт • Дрель-шурупверт аккумуляторный • Akkumulátoros fűró-csavarbehajtó • Bormasina-surubelnita cu acumulator • Akumulátorová vrtačka - šroubovák • Akumulátorový vrtací skrutkovač • Akumulatorski vrtalnik - vijčanik • Akumulatorinis gręžtuvas - sukutvas • Akumulatora urbjmašina - skrūvgriezis • Akutrell • Пробивен винтоверт • Akumulatorska bušilica - izvijač • Akumulatoriske bušilice - odvijajača • Επαναφορτιζόμενο βραχίονο-κατασφίδο • Taladro atomillador a batería • Trapano avvitavite senza filo • Aparafuradora de batería • Perceuse-visseuse à batterie

Ref. 58G121

NEW



18V



- 2x18V 230V~50Hz
- 1.5Ah
- Ni-Cd
- I:0-350 min⁻¹
II:0-1000 min⁻¹
- 25 Nm
- 23+1 positions
- left-right
- 5h
- 1,8 kg
- 0/4
- 213 mm
215 mm

EAN 5902062581211

GRAPHITE

Wiertarko-wkrętarka akumulatorowa
 Cordless drill • Akkubohrschrauber • Аккумуляторная дрель-шурупверт • Дрель-шурупверт аккумуляторный • Akkumulátoros fűró-csavarbehajtó • Bormasina-surubelnita cu acumulator • Akumulátorová vrtačka - šroubovák • Akumulátorový vrtací skrutkovač • Akumulatorski vrtalnik - vijčanik • Akumulatorinis gręžtuvas - sukutvas • Akumulatora urbjmašina - skrūvgriezis • Akutrell • Пробивен винтоверт • Akumulatorska bušilica - izvijač • Akumulatoriske bušilice - odvijajača • Επαναφορτιζόμενο βραχίονο-κατασφίδο • Taladro atomillador a batería • Trapano avvitavite senza filo • Aparafuradora de batería • Perceuse-visseuse à batterie

Ref. 58G127

NEW



18V



- 2x18V 230V~50Hz
- 1.5Ah
- Ni-Cd
- I:0-350 min⁻¹
II:0-1000 min⁻¹
- 25 Nm
- 23+1 positions
- left-right
- 1h
- 1,8 kg
- 0/4
- 213 mm
215 mm

EAN 5902062581273

Wiertarko-wkrętarka akumulatorowa

Cordless drill • Akkubohrschrauber • Аккумуляторная дрель-шуруповёрт • Дрель-шуруповёрт аккумуляторный • Akkumulátoros fúró – csavarbehajtó • Bormasina-surubelnita cu acumulator • Akumulátorová vrtačka - šroubovák • Akumulátorový vrtací skrutkovač • Akumulatorski vrtnik – vijčnik • Akumulatorinis gręžtuvas – suktyvas • Akumulatora urbmašina – skrūvgriezis • Akutrell • Пробивен винтовёрт • Akumulatorska bušilica - izvijač • Akumulatorske bušilice – odvijajača • Επαναφορτιζόμενο βραχίονο-κατσαβίδο • Taladro atornillador a batería • Trapano avvitavite senza filo • Aparafuradora de batería • Perceuse-visseuse à batterie

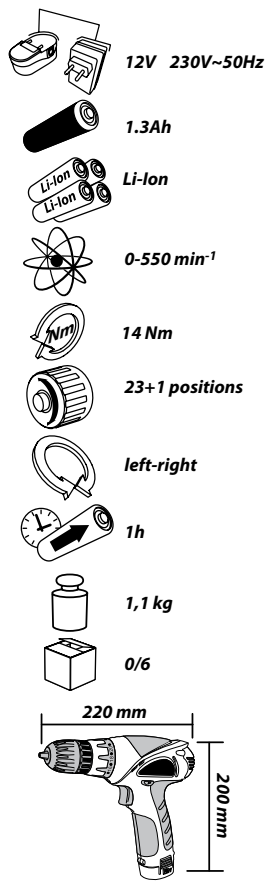

EAN 5902062581303



12 V

Ref. 58G130



Wiertarko-wkrętarka akumulatorowa

Cordless drill • Akkubohrschrauber • Аккумуляторная дрель-шуруповёрт • Дрель-шуруповёрт аккумуляторный • Akkumulátoros fúró – csavarbehajtó • Bormasina-surubelnita cu acumulator • Akumulátorová vrtačka - šroubovák • Akumulátorový vrtací skrutkovač • Akumulatorski vrtnik – vijčnik • Akumulatorinis gręžtuvas – suktyvas • Akumulatora urbmašina – skrūvgriezis • Akutrell • Пробивен винтовёрт • Akumulatorska bušilica - izvijač • Akumulatorske bušilice – odvijajača • Επαναφορτιζόμενο βραχίονο-κατσαβίδο • Taladro atornillador a batería • Trapano avvitavite senza filo • Aparafuradora de batería • Perceuse-visseuse à batterie

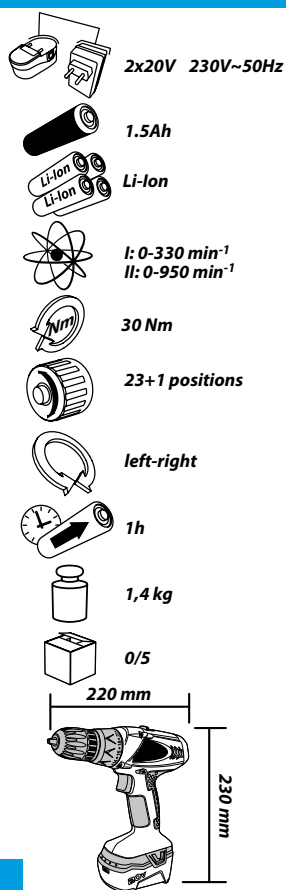

EAN 5902062581341



20 V

GRAPHITE

Ref. 58G134



GRAPHITE

Battery • Akkumulator • Аккумулятор • Акумулятор • Akkumulátor • Acumulator • Akumulátor • Akumulátor • Akumulator • AAKumulátorius • Akumulators • Aku • Акумулятор • Akumulator • Akumulator • Ηλεκτρικός συσσωρευτής • Batería • Accumulatore • Bateria • Batterie

Akkumulator

Ref. **58G111-12**

Ref. **58G116-12**

14,4V



for: **58G111, 58G116**



14,4V 230V~50Hz



1.3Ah



Ni-Cd



0/1

EAN 5902062476036
EAN 5902062476043

GRAPHITE

Battery • Akkumulator • Аккумулятор • Акумулятор • Akkumulátor • Acumulator • Akumulátor • Akumulátor • Akumulator • AAKumulátorius • Akumulators • Aku • Акумулятор • Akumulator • Akumulator • Ηλεκτρικός συσσωρευτής • Batería • Accumulatore • Bateria • Batterie

Akkumulator

Ref. **58G121-12**

Ref. **58G127-12**

18V



for: **58G121, 58G127**

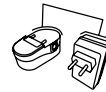

18V 230V~50Hz



1.5Ah



Ni-Cd



0/1

EAN 5902062476050
EAN 5902062476067

GRAPHITE

Battery • Akkumulator • Аккумулятор • Акумулятор • Akkumulátor • Acumulator • Akumulátor • Akumulátor • Akumulator • AAKumulátorius • Akumulators • Aku • Акумулятор • Akumulator • Akumulator • Ηλεκτρικός συσσωρευτής • Batería • Accumulatore • Bateria • Batterie

Akkumulator

Ref. **58G130-12**

12V



for: **58G130**



12V 230V~50Hz



1.3Ah



Li-Ion



0/1

EAN 5902062469281

GRAPHITE

Battery • Akkumulator • Аккумулятор • Акумулятор • Akkumulátor • Acumulator • Akumulátor • Akumulátor • Akumulator • AAKumulátorius • Akumulators • Aku • Акумулятор • Akumulator • Akumulator • Ηλεκτρικός συσσωρευτής • Batería • Accumulatore • Bateria • Batterie

Akkumulator

Ref. **58G134-12**

20V



for: **58G134**

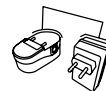

20V 230V~50Hz



1.5Ah



Li-Ion



0/1

EAN 5902062469298

MINISZLIFIERKI WKREŃTARKI SIECIOWE



Max-Speed-Function jest opcją dwupołożeniowego włącznika umożliwiającą automatyczne załączenie maksymalnych obrotów.

Max-Speed-Function is an option for two position switch, which allows to turn on maximum rotational speed automatically.

Max-Speed-Function – это двухрежимная кнопка включения с функцией автоматического включения максимальной частоты вращения.



Cyfrowy wyświetlacz prędkości obrotowej pozwala kontrolować parametry pracy.

Rotational speed digital display allows to control working parameters.

Цифровой дисплей с отображением частоты вращения позволяет контролировать рабочие параметры.

- **Zastosowanie dołączonego do zestawu wałka giętkiego umożliwia wygodną i bardzo precyzyjną pracę.**
- Use of flexible shaft included in the set allows for comfortable and very precise work.
- Входящий в комплект гибкий валик обеспечивает комфортную и очень точную работу.
- **Precyzyjna, skokowa regulacja prędkości obrotowej.**
- Precise step adjustment of rotational speed.
- Точная, ступенчатая регулировка частоты вращения.
- **Blokada wrzeciona ułatwia wymianę akcesoriów.**
- Spindle lock facilitates accessory replacement.
- Фиксация шпинделя облегчает замену рабочих принадлежностей.
- **Antypoślizgowe elementy obudowy zwiększają komfort pracy.**
- Anti-slip parts of casing improve work comfort.
- Антискользящие элементы корпуса повышают комфорт работы.



Ref. 59G018



175W

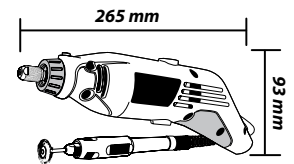
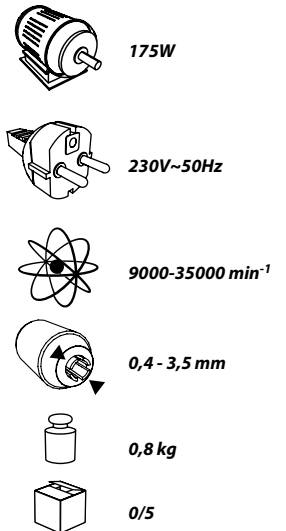

EAN 5902062590183

Ref. 58G790



710W

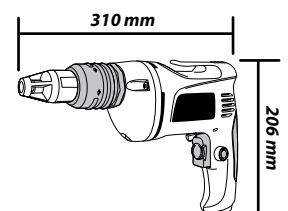
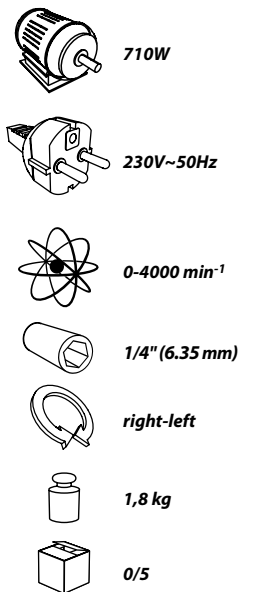
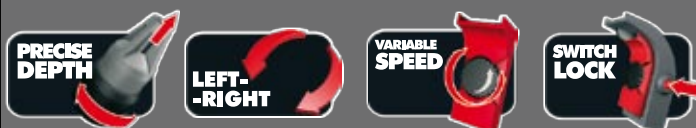

EAN 5902062587909

WIERTARKI UDAROWE

MIESZARKI

MIESZADŁA



Aluminiowy korpus obudowy przekładni zwiększa wydajność chłodzenia, co przedłuża trwałość urządzenia.

Aluminium casing of the gear body improves cooling efficiency and prolongs life of the tool.

Алюминиевый корпус передачи улучшает эффективность охлаждения, что увеличивает ресурс оборудования.



Dwubiegowa konstrukcja przekładni pozwala dopasować obroty i moment obrotowy do różnych prac.

Two gear design allows to adjust rotational speed and torque to various tasks.

Двухрежимная конструкция передачи позволяет подобрать частоту вращения и крутящий момент в зависимости от потребности.



Stalowy uchwyt samozaciskowy umożliwia beznarzędziową wymianę akcesoriów.

Steel keyless chuck allows toolless accessory replacement.

Стальной самозажимной патрон позволяет заменять рабочие принадлежности без специального ключа.

- **Pełna regulacja ustawienia kąta rękojeści dodatkowej.**
- Full angle adjustment of additional handle.
- Полная регулировка угла фиксации дополнительной рукоятки.
- **Antypoślizgowa powierzchnia rękojeści zwiększa komfort pracy.**
- Handle anti-slip surface improves work comfort.
- Антискользящая поверхность рукоятки повышает комфорт работы.
- **Płynna regulacja obrotów pozwala dostosować prędkość obrotową do rodzaju wierzonego materiału.**
- Rotational speed continuous adjustment allows to match the speed to type of processed material.
- Плавная регулировка частоты вращения позволяет подобрать частоту в зависимости от обрабатываемого материала.
- **Zastosowana blokada włącznika umożliwia pracę ciągłą.**
- Implemented main switch lock allows continuous work.
- Фиксация кнопки включения для непрерывной работы.

GRAPHITE



Wiertarka udarowa

Impact drill • Bohrerhammer • Дрель ударная • Дрель ударный • Útvefúró • Perforator de lovít • Přiklepová vrtačka • Přiklepová vrtačka • Udarni vrtnalnik • Gręźtuvas su kalimu • Sitiēna urbīmašīna • Löökdrell • Бормашина ударна • Udarna busilica • Udarna busilica • Κρουστικό δρέπανο • Taladro de impacto • Trapano traforatore • Berbequim de impacto • Perceuse à choc

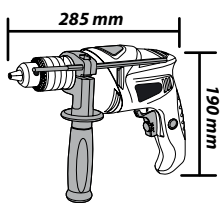
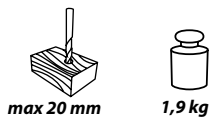
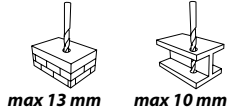
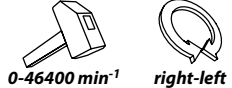
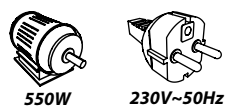

EAN 5902062587152



550W

Ref. 58G715



Wiertarka udarowa

Impact drill • Bohrerhammer • Дрель ударная • Дрель ударный • Útvefúró • Perforator de lovít • Přiklepová vrtačka • Přiklepová vrtačka • Udarni vrtnalnik • Gręźtuvas su kalimu • Sitiēna urbīmašīna • Löökdrell • Бормашина ударна • Udarna busilica • Udarna busilica • Κρουστικό δρέπανο • Taladro de impacto • Trapano traforatore • Berbequim de impacto • Perceuse à choc

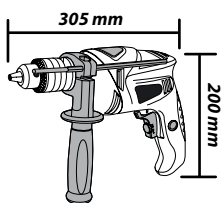
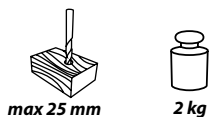
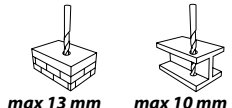
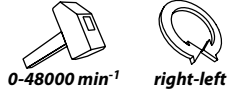
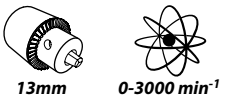
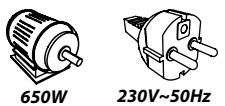

EAN 5902062587169



650W

Ref. 58G716



GRAPHITE

Impact drill • Bohrerhammer • Дрель ударная • Дриль ударний • Ütvefúró • Perforator de lovít • Přiklepová vrtačka • Přiklepová vrtačka • Udarni vrtnik • Gręztuvas su kalimu • Sítiena urbjmašina • Löökdrill • Бормашина ударна • Udarna busilica • Udarna busilica • Κρουστικό όργανο • Taladro de impacto • Trapano traforatore • Berbequim de impacto • Perceuse à choc

Wiertarka udarowa

Ref. 58G717



750W

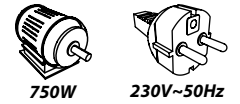

750W

230V~50Hz



13mm



0-3000 min⁻¹



0-48000 min⁻¹



right-left



max 13 mm

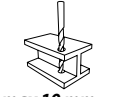

max 10 mm



max 30 mm



2,1 kg



0/5

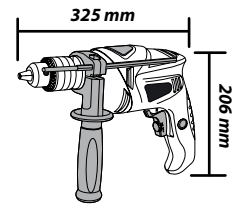

EAN 5902062587176

GRAPHITE

Impact drill • Bohrerhammer • Дрель ударная • Дриль ударний • Ütvefúró • Perforator de lovít • Přiklepová vrtačka • Přiklepová vrtačka • Udarni vrtnik • Gręztuvas su kalimu • Sítiena urbjmašina • Löökdrill • Бормашина ударна • Udarna busilica • Udarna busilica • Κρουστικό όργανο • Taladro de impacto • Trapano traforatore • Berbequim de impacto • Perceuse à choc

Wiertarka udarowa

Ref. 58G718



810W

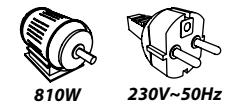

810W

230V~50Hz



13mm



I: 0-1200 min⁻¹
II: 0-2800 min⁻¹



0-19200 min⁻¹
0-44800 min⁻¹



right-left



max 16 mm

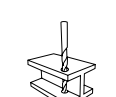

max 13 mm



max 40 mm



2,7 kg



0/5

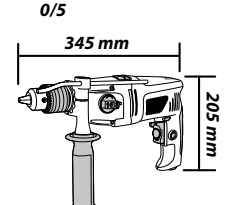

EAN 5902062587183

Wiertarka udarowa

Impact drill • Bohrerhammer • Дрель ударная • Дрель ударный • Útvefúró • Perforator de lovít • Příkladová vrtačka • Příkladová vrtačka • Udami vrtalnik • Gręźtuvas su kalimu • Sítiena urbjmašina • Löökdrell • Бормашина ударна • Udarna bušilica • Udarna bušilica • Κρουστικό δρέπανο • Taladro de impacto • Trapano traforatore • Berbequim de impacto • Perceuse à choc

GRAPHITE

Ref. **58G711**

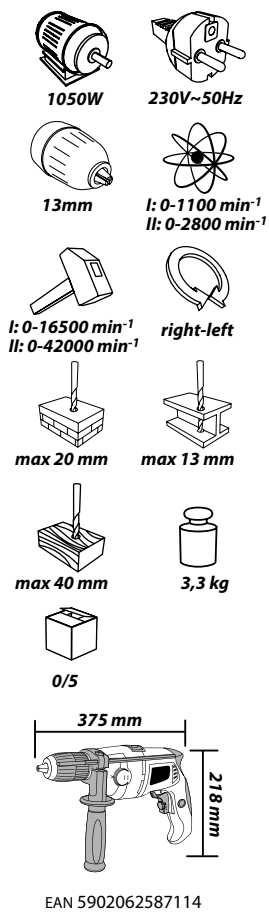

1050W



Mieszarka

Mixer • Mischmaschine • Мешалка • Змішувач • Keverő • Malaxor • Míchačka • Miešac • Mešalnik • Maišyklās • Maisītājs • Vispel • Бъркачка • Mješalica • Mešalica • Αναθετήρας • Mezdador • Miscelatore • Misturador eléctrica • Mélangeur électrique

GRAPHITE

Ref. **58G782**

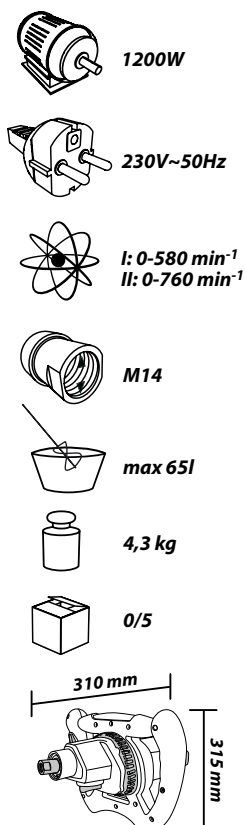

1200W



Ref. **58G784**



1600W

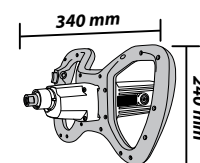
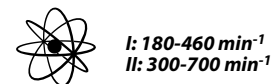
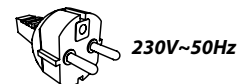

EAN 5902062587846

Ref. **58G788**

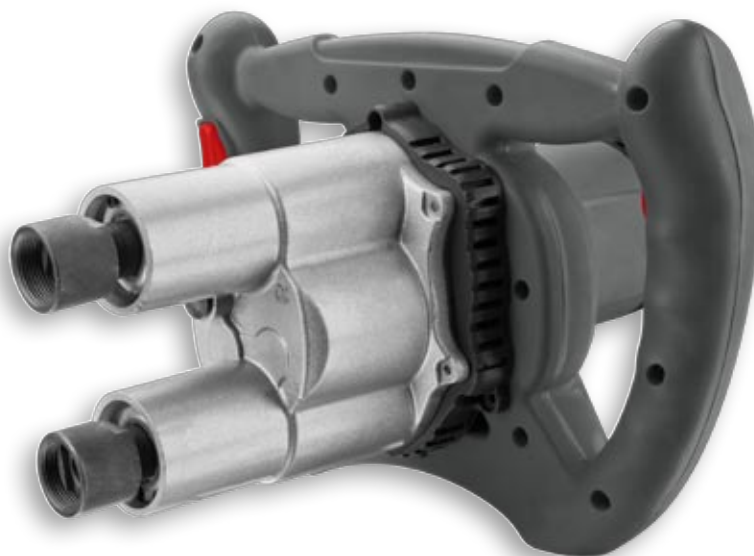

1600W

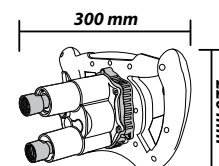
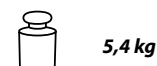
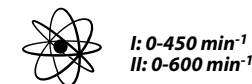

EAN 5902062587886

Mieszadło

Mixer • Rührer • Мешалка • Міксер • Keverőszár • Mixer • Mišačka • Miešac • Mešalnik • Maişyklé • Mikseris
• Segisti • Бъркалка • Міксер • Міксер • Μίκτης • Cesta agitadora • Agitatore • Misturador • Agitateur

for: 58G782



M14



0/1



Ref. **58G782-96**

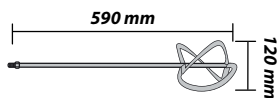

EAN 5902062469113

Mieszadło

Mixer • Rührer • Мешалка • Міксер • Keverőszár • Mixer • Mišačka • Miešac • Mešalnik • Maişyklé • Mikseris
• Segisti • Бъркалка • Міксер • Міксер • Μίκτης • Cesta agitadora • Agitatore • Misturador • Agitateur

for: 58G784



M14



0/1



Ref. **58G784-96**

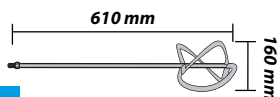

EAN 5902062469304

Ref. **58G784-97**



for: **58G784**

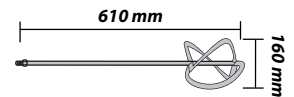

EAN 5902062469311

Ref. **58G788-96**

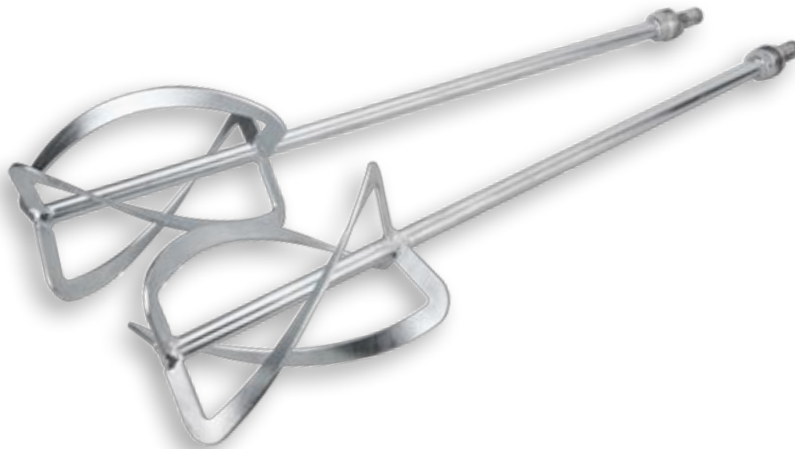

for: **58G788**

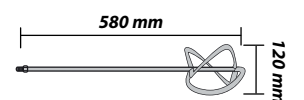

EAN 5902062469328

MŁOTOWIERTARKI



Unikalna 4 funkcja pozwala na bezstopniową regulację kąta ustawienia dłuta płaskiego, szczególnie przy precyzyjnych pracach podkuwania.

Unique 4-function feature allows continuous adjustment of flat chisel angle setting, which is especially useful in very precise chiselling works.

Уникальная 4 функция позволяет плавно регулировать угол крепления плоского зубила, что особенно востребовано при точном долблении.



Aluminiowy korpus obudowy przekładni zwiększa wydajność chłodzenia, co przedłuża trwałość urządzenia.

Aluminium casing of the gear body improves cooling efficiency and prolongs life of the tool.

Алюминиевый корпус передачи улучшает эффективность охлаждения, что увеличивает ресурс оборудования.



Kontrolka podłączenia młotowiertarki do sieci zasilającej zwiększa bezpieczeństwo użytkownika.

Mains indicator of rotary hammer drill improves user safety.

Контрольная лампа включения перфоратора в сеть питания увеличивает безопасность работы.



Sprzęgło bezpieczeństwa chroni użytkownika podczas pracy w przypadku zakleszczenia się wiertła.

Safety clutch protects the user during work in case of drill jam.

Предохранительная муфта защищает пользователя в случае заклинивания сверла во время работы.















GRAPHITE

- Posiada możliwość wyłączenia uderzenia umożliwiając wiercenie w drewnie, metalu, ceramice oraz wkręcanie i wykręcanie wkrętów.
- The tool allows to switch the impact function off, which allows to drill in wood, metal, ceramics, screwing and unscrewing screws.
- Можно выключить удар, что позволит сверлить в дереве, металле, керамике, а также вкручивать и выкручивать шурупы.
- Kompaktowy kształt młotowiertarki umożliwia wygodną pracę nawet w trudniej dostępnych miejscach.
- Rotary hammer drill compact design allows comfortable operation even at hardly accessible places.
- Компактная форма перфоратора обеспечивает комфортную работу даже в труднодоступных местах.
- Antypoślizgowa powierzchnia głównego włącznika zwiększa komfort pracy szczególnie podczas długotrwałego użytkowania.
- Anti-slip surface of the main switch improves work comfort, especially during long lasting use.
- Антискользящее покрытие кнопки включения создает повышенный комфорт при длительной работе.
- W zestawie znajduje się uchwyt kluczykowy z adapterem pozwalający na wykorzystanie tradycyjnego osprzętu.
- The set includes key chuck with adapter for use with traditional equipment.
- В комплект входит патрон под ключ с переходником, позволяющий использовать стандартную оснастку.
- Zewnętrzny dostęp do szczotek węglowych ułatwia ich wymianę.
- External access to carbon brushes for easy replacement.
- Доступ к угольным щеткам облегчает их замену.

Młotowiertarka

Rotary Hammer Drill • Hammerbohrmaschine • Πεφφορατορ • Перфоратор • Fűrókalapács • Ciocan rotopercutor • Vrtací kladivo • Vrtacie kladivo • Vrtalno kladivo • Perforatorius • Perforators • Puurvasar • Πεφφορατορ • Čekić-bušilica • Čekić-bušilica • Κρουστικό δρέπανο • Martillo percutor SDS-Plus • Martello perforatore • Martelo-Berbequim • Perceuse-marteau

Ref. **58G509**

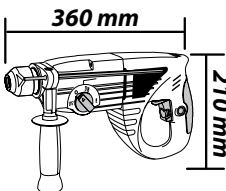
 900W	 230V~50Hz
 SDS+	 0-1000 min⁻¹
 0-5400 min⁻¹	 2.3 J
 right-left	 max 26 mm
 max 13 mm	 max 40 mm
 4m	 3,1 kg
 0/2	
 360 mm (length) 210 mm (height)	
EAN 5902062585097	















900W



Młotowiertarka

Rotary Hammer Drill • Hammerbohrmaschine • Πεφφορατορ • Перфоратор • Fűrókalapács • Ciocan rotopercutor • Vrtací kladivo • Vrtacie kladivo • Vrtalno kladivo • Perforatorius • Perforators • Puurvasar • Πεφφορατορ • Čekić-bušilica • Čekić-bušilica • Κρουστικό δρέπανο • Martillo percutor SDS-Plus • Martello perforatore • Martelo-Berbequim • Perceuse-marteau

Ref. **58G518**

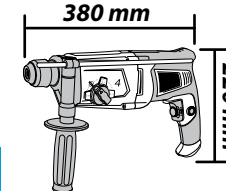
 800W	 230V~50Hz
 SDS+	 0-950 min⁻¹
 0-4500 min⁻¹	 2.3 J
 right-left	 max 26 mm
 max 13 mm	 max 40 mm
 4m	 3,6 kg
 0/2	
 380 mm (length) 220 mm (height)	
EAN 5902062585189	



800W



GRAPHITE

Rotary Hammer Drill • Hammerbohrmaschine • Перфоратор • Перфоратор • Fúrókalapács • Ciocan rotopercutor • Vrtací kladivo • Vrtacie kladivo • Vrtalno kladivo • Perforatorius • Perforators • Puurvasar • Перфоратор • Čekič-bušilica • Čekič-bušilica • Κρουστικό δράπανο • Martillo percutor SDS-Plus • Martello perforatore • Martelo-Berbequim • Perceuse-marteau

Młotowiertarka

Ref. **58G519**



900W

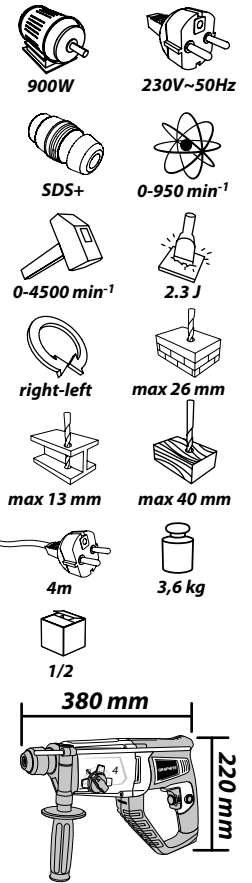

EAN 5902062585196

GRAPHITE

Rotary Hammer Drill • Hammerbohrmaschine • Перфоратор • Перфоратор • Fúrókalapács • Ciocan rotopercutor • Vrtací kladivo • Vrtacie kladivo • Vrtalno kladivo • Perforatorius • Perforators • Puurvasar • Перфоратор • Čekič-bušilica • Čekič-bušilica • Κρουστικό δράπανο • Martillo percutor SDS-Plus • Martello perforatore • Martelo-Berbequim • Perceuse-marteau

Młotowiertarka

Ref. **58G548**



950W

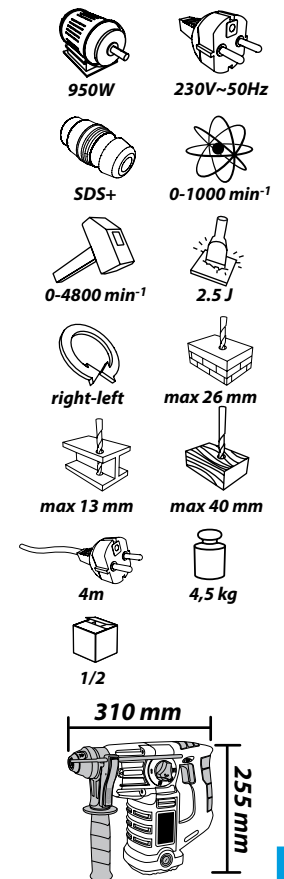
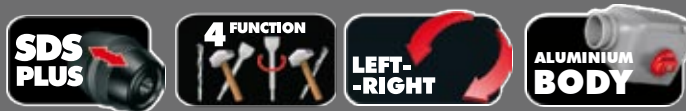

EAN 5902062585486

MŁOTY UDAROWE

MŁOTY WYBURZENIOWE



System antywibracyjny rękojeści AVH redukuje wibracje powstające podczas pracy.

Handle antivibration system AVH reduces vibrations during work.

Антивибрационная система рукоятки AVH уменьшает вибрацию во время работы.



Młot udarowy posiada możliwość wyłączenia uderzenia umożliwiającą wiercenie w drewnie, metalu, ceramice.

Hammer drill allows to switch impact function off, which allows to drill in wood, metal and ceramics.

В перфораторе/бетоноломе можно отключить удар и сверлить в дереве, металле и керамике.



Dwumaterialowa powierzchnia rękojeści głównej zwiększa komfort pracy szczególnie podczas długotrwałego użytkowania.

Two material surface of the main handle improves work comfort, especially during long lasting use.

Двухкомпонентное покрытие основной рукоятки создает повышенный комфорт при длительной работе.



Sprzęgło bezpieczeństwa chroni użytkownika podczas pracy w przypadku zakleszczenia się wiertła.

Safety clutch protects the user during work in case of a drill jam.

Предохранительная муфта защищает пользователя в случае заклинивания сверла во время работы.



GRAPHITE



Młot udarowy

Hammer drill • Schlaghammer • Молоток отбойный • Перфоратор • Fúrókalapács • Perforator • ciocan de lovit • Kyvadlové kladivo • Skrutkovač AKU • Udarno kladivo • Perforatorius • Sítiena urbmašina • Vasardrell • Къртач • Сeкиć буšилца • Hamer busilica • Κρουστικό δρεπάνι • Martillo de percusión • Martello perforatore • Martelo de impacto • Marteau à chocs

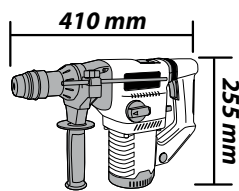
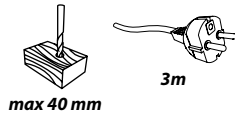
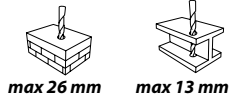
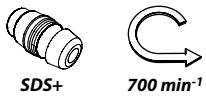
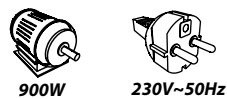

EAN 5902062588593



900W

Ref. **58G859**

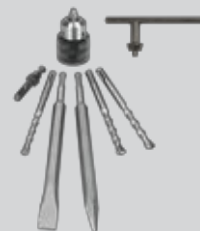

Młot udarowy

Hammer drill • Schlaghammer • Молоток отбойный • Перфоратор • Fúrókalapács • Perforator • ciocan de lovit • Kyvadlové kladivo • Skrutkovač AKU • Udarno kladivo • Perforatorius • Sítiena urbmašina • Vasardrell • Къртач • Сeкиć буšилца • Hamer busilica • Κρουστικό δρεπάνι • Martillo de percusión • Martello perforatore • Martelo de impacto • Marteau à chocs

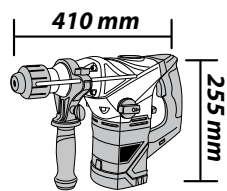
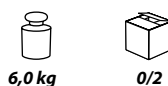
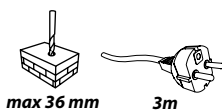
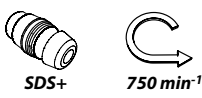
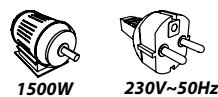

EAN 5902062588623



1500W

Ref. **58G862**



GRAPHITE

Hammer drill • Schlaghammer • Монокок стбойный • Перфоратор • Fúrókalapács • Perforator - ciocan de lovit • Kyvadlové kladivo • Skrutkovač AKU • Udarno kladivo • Perforatorius • Sitiena urbjmašina • Vasardrell • Кървач • Čekić bušilica • Hammer busilica • Κρουστικό βρεπάνι • Martillo de percusión • Martello perforatore • Martelo de impacto • Marteau à chocs

Ref. **58G874**



1250W



Młot udarowy

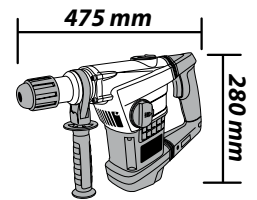
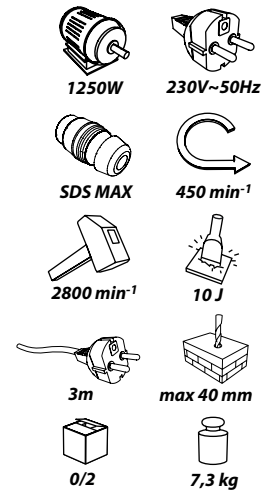

EAN 5902062588746

GRAPHITE

Demolition hammer • Hammer für Ausbrucharbeiten • Бетонолом • Монокок відбійний • Βοντόκαλαράς • Ciocan demolator • Bouračací kladivo • Búracie kladivo • Rušilno kladivo • Atskélimo plaktukas • Betona laužnis • Piikvasar • Кървач • Čekić za lomljenje • Čekić za rušenje • Σφύρα • Martillo picador • Martello demolitore • Martelo de demolição • Marteau de démolition

Ref. **58G876**



1200W



Młot wyburzeniowy

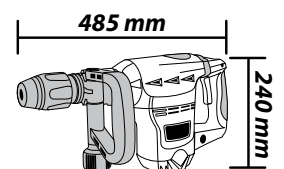
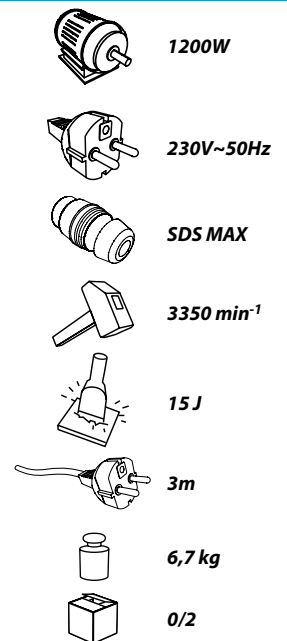

EAN 5902062588760

Młot wyburzeniowy

Demolition hammer • Hammer für Ausbrucharbeiten • Бетонолом • Молоток відбійний • Vontókalapács • Ciocan demolator • Vouřací kladivo • Búracie kladivo • Rušilno kladivo • Atskėlimo plaktukas • Betona laužnis • Piikvasar • Кървач • Čekič za lomljenje • Čekič za rušenje • Σφύρα • Martillo picador • Martello demolitore • Martelo de demolição • Marteau de démolition



1700W



230V~50Hz



SDS MAX



160-320 min⁻¹



950-1900 min⁻¹



27 J



max 50 mm

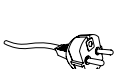

3m



11,5 kg



0/1

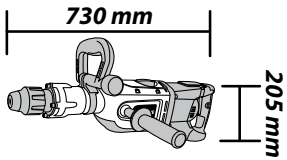

EAN 5902062588784



Ref. **58G878**



1700W



Młot wyburzeniowy

Demolition hammer • Hammer für Ausbrucharbeiten • Бетонолом • Молоток відбійний • Vontókalapács • Ciocan demolator • Vouřací kladivo • Búracie kladivo • Rušilno kladivo • Atskėlimo plaktukas • Betona laužnis • Piikvasar • Кървач • Čekič za lomljenje • Čekič za rušenje • Σφύρα • Martillo picador • Martello demolitore • Martelo de demolição • Marteau de démolition



1700W



230V~50Hz



HEX 30 mm



1300 min⁻¹



45 J



3m



17 kg



0/1

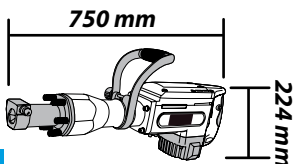

EAN 5902062588678



Ref. **58G867**



1700W





SZLIFIERKI KĄTOWE BRUZDOWNICE POLERKI PRZECINARKI DO METALU



Beznarzędziowa regulacja osłony tarczy.

Toolless adjustment of the disc shield.

Регулировка защитного кожуха диска без использования ключа.



Blokada wrzeciona ułatwia wymianę narzędzi roboczych.

Spindle lock facilitates replacement of working tools.

Фиксация шпинделя облегчает замену рабочих принадлежностей.

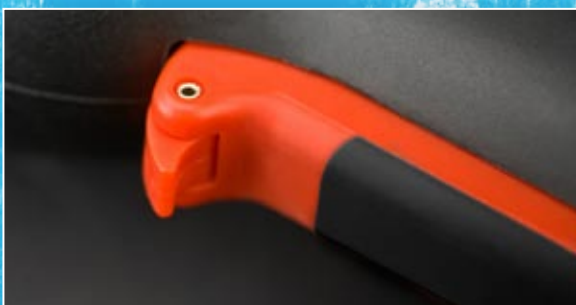

Specjalistyczny dwufunkcyjny włącznik z blokadą zabezpieczającą przed przypadkowym włączeniem.

Special two function switch with a lock that protects against accidental start up.

Специальная двухрежимная кнопка включения с блокировкой от непреднамеренного включения.



GRAPHITE



Szlifierka kątowa

Angle grinder • Winkelschleifer • Шлифмашина угловая • Шліфмашинка наріжна • Sarokcsiszoló • Maşină unghiulară de şlefuit • Bruska úhlová • Brúška uhlová • Kotni brusilnik • Kampinis šlifuoκlis • Leņķasfīrmašīna • Nurklihvija • Ёрлошлайф • Bruslicakutna • Bruslicaugaona • Γωνιακόστροχός • Amoladora angular • Rettificatrice angolare • Discodelimar p.cantos • Meuleused'angle



710W



230V~50Hz

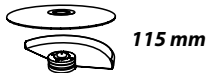

115 mm

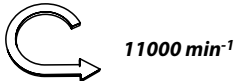

11000 min⁻¹



M14

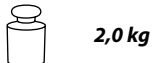

2,0 kg



1/10

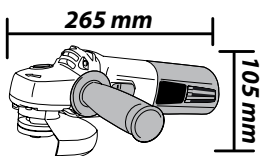

EAN 5902062588623



710W

Ref. 59G062



Szlifierka kątowa

Angle grinder • Winkelschleifer • Шлифмашина угловая • Шліфмашинка наріжна • Sarokcsiszoló • Maşină unghiulară de şlefuit • Bruska úhlová • Brúška uhlová • Kotni brusilnik • Kampinis šlifuoκlis • Leņķasfīrmašīna • Nurklihvija • Ёрлошлайф • Bruslicakutna • Bruslicaugaona • Γωνιακόστροχός • Amoladora angular • Rettificatrice angolare • Discodelimar p.cantos • Meuleused'angle



860W



230V~50Hz



125 mm

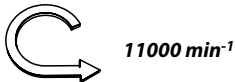

11000 min⁻¹



M14

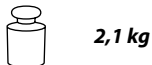

2,1 kg

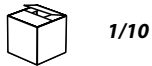

1/10

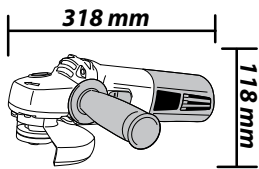

EAN 5902062590862

NEW

Ref. 59G086



860W



GRAPHITE

Angle grinder • Winkelschleifer • Шлифмашина угловая • Шліфмашинка наріжна • Sarokcsiszoló • Maşină unghiulară de şlefuit • Bruska úhlová • Brúska uhlová • Kotni brusilnik • Kämpinis šlifuoškis • Leņķaslīpmašīna • Nurklihvija • Ърлошлайф • Brusilica kutna • Brusilica ugaona • Γωνιακό στροχός • Amoladora angular • Rettificatrice angolare • Discodelimarp.cantos • Meuleuse d'angle

Ref. **59G092**



1010W



1010W

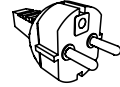

230V~50Hz

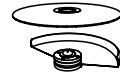

125 mm



11000 min⁻¹



M14



X



2,5 kg

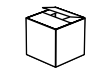

0/4

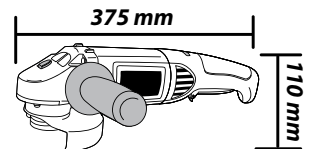

EAN 5902062590923

GRAPHITE

Angle grinder • Winkelschleifer • Шлифмашина угловая • Шліфмашинка наріжна • Sarokcsiszoló • Maşină unghiulară de şlefuit • Bruska úhlová • Brúska uhlová • Kotni brusilnik • Kämpinis šlifuoškis • Leņķaslīpmašīna • Nurklihvija • Ърлошлайф • Brusilica kutna • Brusilica ugaona • Γωνιακό στροχός • Amoladora angular • Rettificatrice angolare • Discodelimarp.cantos • Meuleuse d'angle

Ref. **59G096**



960W



960W

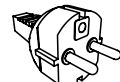

230V~50Hz



125 mm



3000-11000 min⁻¹



M14



X



2,5 kg



0/4

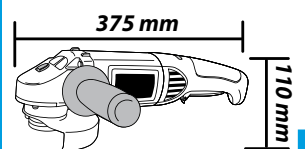

EAN 5902062590961

Szlifierka kątowa

Angle grinder • Winkelschleifer • Шлифмашина угловая • Шліфмашина кутівна • Sarokcsiszoló • Maşină unghiulară de şlefuit • Brska úhlová • Brúška uhlová • Kotni brusilnik • Kampinis šlifuoškis • Leňkaslipmašina • Nurklihvija • брлошлайф • Brusilicakutna • Brusilicaugaona • Γωνιακόστροφές • Amoladora angular • Rettificatrice angolare • Discodelimar p.cantos • Meuleused angle

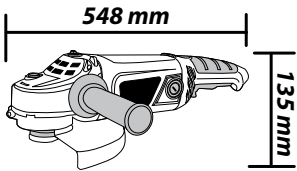
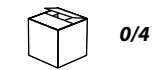
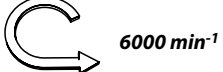
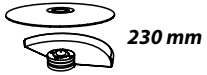
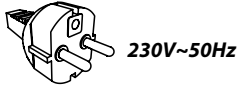

EAN 5902062592064



NEW

Ref. **59G206**

2400W



Przecinarka do metalu

Portable cut-off saw • Metall-Trennmaschine • Пила по металлу • Пилка монтажна • Fémдарaboló • Aparat portabil de debitat în metale • Rezačka kovu • Rezačka na kov • Rezalnik kovine • Metalo pjúkľas • Metāla griezējs • Metallisäepink • Секач за метал • Rezalica za metal • Sekáč za metal • Πρίόνι μετάλλου • Cortador para metal • Troncatrice per metallo • Cortador de plasma • Tronçonneuse à plasma

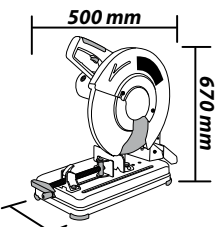
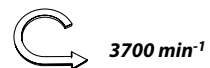
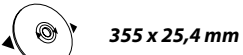

EAN 5902062598721



2000 W

Ref. **59G872**



GRAPHITE









Wall Chaser • Nutfräse • Штроборез • Штроборіс • Falhoronymaró • Mašínà de táiat caneluri • Drážkovací frézka • Drážkovacia fréza • Zidni rezkalnik • Múro freza • Rievgrieznis • Soonelõikur • Фреза за канали в бетон • Pila za precizno rezanje • Mašina za praviljenej brazda • Φρέζα αλληλώσεων • Rozadora • Fresatrice per muratura • Máquina de raiar canos • Rainureuse

Ref. 59G370



1320W



-  1320W
-  230V~50Hz
-  9000 min⁻¹
-  125 mm
-  8-30 mm
-  8-26 mm
-  3m
-  4,2 kg
-  0/4

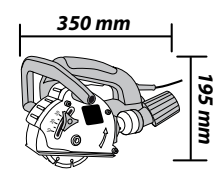

EAN 5902062593702

GRAPHITE







Electric sander-polisher • Schleif- und Poliermaschine • Полировальная шлифмашина • Машина шліфувально-полірувальна • Csiszoló-polírozó • Mašínà de šlefuit - lustruit • Bruska/leštička • Brúska-leštička • Brusilnik-polirnik • Šlifuočlis - poliruočlis • Slīpēšanas un pūlēšanas mašīna • Lihv-poleermasin • Полираща шлайфмашина • Brusilica za poliranje • Brusilica za poliranje • Λιαστικός σταβρωτήρας • Amoladora pulidora • Levigatrice-lucidatrice • Disco de limar, polir • Meuleuse-ponceuse

Ref. 59G242



1200W



-  1200W
-  230V~50Hz
-  900-3800 min⁻¹
-  180 mm
-  SOFT START
-  2,8 kg
-  0/4

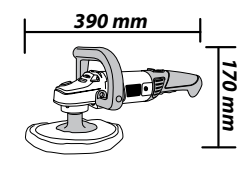

EAN 5902062592422

SZLIFIERKI OSCYLACYJNE

SZLIFIERKI MIMOŚRODOWE

SZLIFIERKI TAŚMOWE

SZLIFIERKI DO GIPSU



Wymienna stopa pozwala dostosować odpowiedni rozmiar do wykonywanej pracy.

Replaceable pad allows to match its size to the task at hand.

Сменная подошва позволяет подобрать размер в зависимости от планируемой работы.



Zintegrowany system odprowadzania pyłu poprawia wygodę pracy.

Integrated dust extraction system improves work comfort.

Интегрированная система пылеудаления повышает комфорт работы.

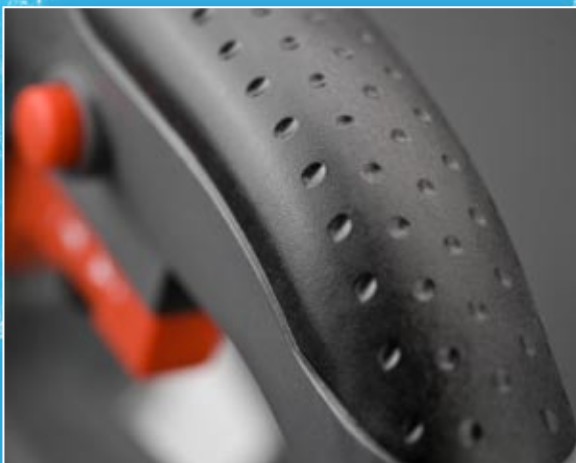

Antypoślizgowa powierzchnia rękojeści zwiększa komfort pracy, szczególnie przydatna podczas szlifowania dużych powierzchni.

Anti-slip handle surface improves work comfort, it is especially useful when sanding large surfaces.

Антискользящее покрытие рукоятки повышает комфорт работы, что особенно важно при шлифовании больших поверхностей.

- Zastosowana blokada włącznika umożliwia pracę ciągłą.
- Implemented main switch lock allows continuous work.
- Фиксация кнопки включения для непрерывной работы.
- Płynna regulacja ilości oscylacji stopy pozwala na dostosowanie jej do rodzaju szlifowanego materiału.
- Continuous adjustment of pad oscillations allows to match it to the type of sanded material.
- Плавная регулировка частоты колебаний подошвы позволяет подобрать частоту в зависимости от обрабатываемого материала.
- Regulowany uchwyt dodatkowy zwiększa wygodę pracy.
- Adjustable additional handle improves work comfort.
- Регулируемая дополнительная рукоятка повышает комфорт работы.



GRAPHITE

Szlifierka oscylacyjna delta

Finishing Sander • Schwingungsschleifer delta • Машина шлифовальная вибрационная • Шліфмашина дельтовидна • Rezgőcsiszoló • Slefútor cu talpa • Vibrační delta bruska • Vibračná delta brúška • Vibracijski brusilnik delta • Šlifuoškis „Delta“ • Lentas šlipmašina • Kolmnurkklīhvija • Вибраціонна шлайфмашина Делта • Oscilatorska brusilica delta • Oscilatorna brusilica delta • Πολυκώ τριβείο • Lijadora orbital delta • Levigatrice a delta • Disco de limar oscilante delta • Meuleuse oscillatoire delta

Ref. 59G335



105W



105W

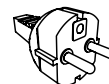

230V~50Hz



12000 min⁻¹



1 mm



140 x 140 x 97 mm



0,9 kg



0/10

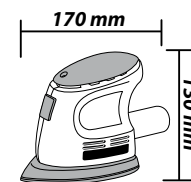

EAN 5902062593351

GRAPHITE

Szlifierka oscylacyjna

Finishing sander • Vibrationsschleifer • Шлифмашина вибрационная • Шліфмашина оциляційна • Rezgőcsiszoló • Strung p/u șlefuire finală • Oscilační bruska • Brúška vibračná • Vibracijski brusilnik • Ploktuminis šlifuoškis • Vibroslipmašina • Taldlīhvija • Шлайф машина • Vibraciona Brusilica • Vibraciona brusilica • Λειαντήρας τελικής επεξεργασίας • Lijadora orbital delta • Rettificatrice oscillatoria • Disco de limar oscilante • Meuleuse oscillatoire

Ref. 59G321

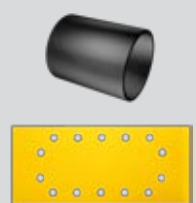

180W



180W



230V~50Hz



11000 min⁻¹



22000 min⁻¹



2 mm



90 x 187 mm



1,6 kg



0/4

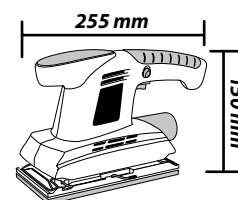

EAN 5902062593214

Szliferka oscylacyjna

Finishing sander • Vibrationsschleifer • Шлифмашина вибрационная • Шліфмашина осциляційна • Rezgőcsiszoló • Strung p/u șlefuire finală • Oscilační bruska • Brúška vibračná • Vibracijski brusilnik • Ploštuminis šlifuoškis • Vibroslipmašina • Taldilivija • Шлайф машина • Vibraciona Brusilica • Vibraciona brusilica • Λειαντήρας τελικής επεξεργασίας • Lijadora orbital delta • Rettificatrice oscillatoria • Disco de limar oscilante • Meuleuse oscillatoire

GRAPHITE

Ref. **59G323**

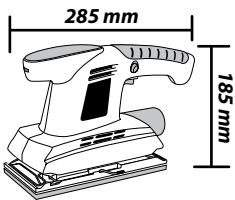
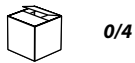
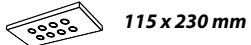
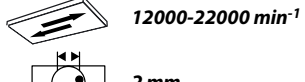

EAN 5902062593238



380W



DUST AWAY

ALUMINIUM BASE

VARIABLE SPEED



Szliferka mimośrodowa

Orbital sander • Exzenterschleifmaschine • Шлифмашина эксцентриковая • Шліфмашина ексцентрична • Dekopírfűrész • Mašinã orbitalã de șlefuit • Excentrickã bruska • Generãtor • Vibracijski brusilnik • Ekscentrinis šlifuoškis • Slipmašina ekscentriskã • Lihvimãsinã • Шлайф машина • Vibraciona Brusilica • Vibraciona brusilica • Παδικό τρίβείο • Rettificatrice eccentrica • Disco de limar • Meuleuse excentrique

GRAPHITE

Ref. **59G344**

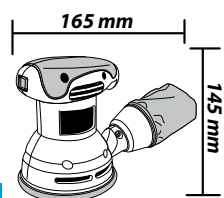
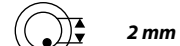
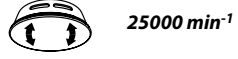
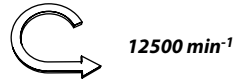
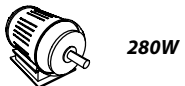

EAN 5902062593443



280W



DUST AWAY

HOOK & LOOP SYSTEM

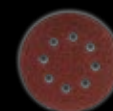

GRAPHITE

Szlifierka mimośrodkowa

Orbital sander • Exzenterschleifmaschine • Шлифмашина эксцентриковая • Шліфмашинка ексцентрична • Dekopírfűrész • Masinã orbitalã de șlefuit • Excentrická bruska • Generátor • Vibracijski brusilnik • Ekscentrinis šlifuoškis • Sljpmãšina ekscentriška • Lihvimisasin • Шлайф машина • Vibraciona Brusilica • Vibraciona brusilica • Παλμικό τρίβείο • Rettificatrice eccentrica • Levigatrice rotoorbitale • Disco de limar • Meuleuse excentrique

Ref. 59G346



450W

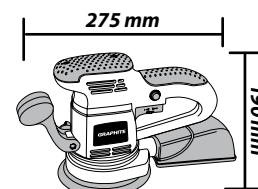
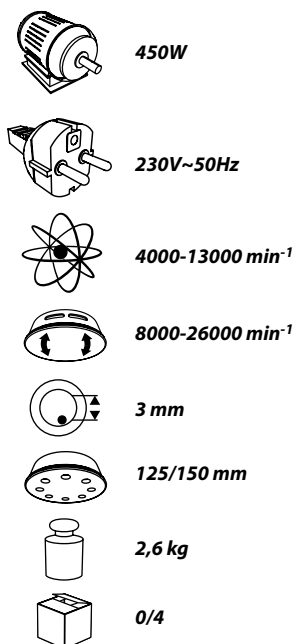
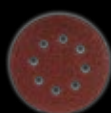

EAN 5902062593467

GRAPHITE

Szlifierka taśmowa

Belt sander • Bandschleifmaschine • Шлифмашина ленточная • Шліфмашинка стрічкова • Szalagcsiszoló • Strung de șlefuit cu bandă • Pásová bruska • Leštíčka + příslušenstvo • Траčni brusilnik • Juostinis šlifuoškis • Lentas sljpmãšina • Lintlihvija • Шлайф машина • Trakasta Brusilica • Trakasta brusilica • Λιαωντρίας με ζώντα • Lijadora de banda • Rettificatrice a nastro • Disco de limar de fita • Meuleuse à bande

Ref. 59G392



800W

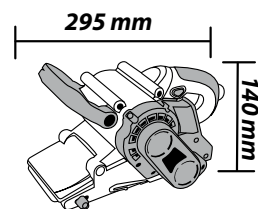
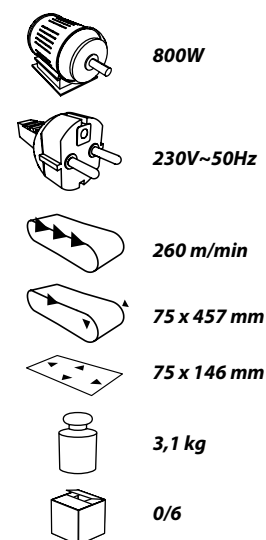

EAN 5902062593924

Szlfiferka tašmowa

Belt sander • Bandschleifmaschine • Шлифмашина ленточная • Шліфмашина стрічкова • Szalagcsiszoló • Strung de șlefuit cu bandă • Pásová bruska • Lešticka + příslušenstvo • Tračni brusilnik • Juostinis šlifuoškis • Lentas slipmašina • Lintlihvija • Шлайф машина • Trakasta Brusilica • Trakasta brusilica • Λειαντήρας με ζώντα • Lijadora de banda • Rettificatrice a nastro • Disco de limar de fita • Meuleuse à bande

GRAPHITE

Ref. **59G394**

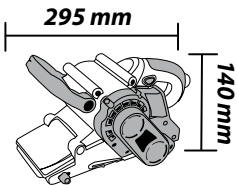
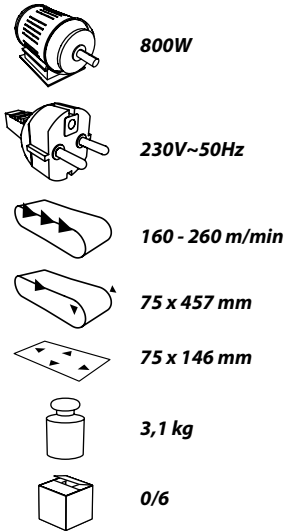

EAN 5902062593948



800W



Szlfiferka do gipsu

Drywall sander • Gipsschleifer • Машина шлифовальная для стен и потолков • Шліфмашина по гіпсу • Falciszoló • Polizor pentru pereti ghips-carton • Bruska na sádru • Brúška na sadru • Brusilnik za gips • Šlifuoškis gipsui • Slipmašina sienu un griestu slipēšanai • Kipslihvija • Шлайфмашина за гипс • Brusilica za gips • Λειαντήρας για τοίχους και ταβάνια • Amoladora para yeso • Levigatrice per cartongesso • Disco de limar p. Gesso • Meuleuse à plâtre

GRAPHITE

Ref. **59G260**

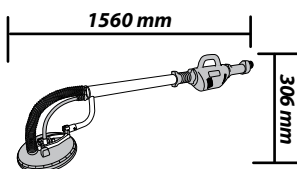
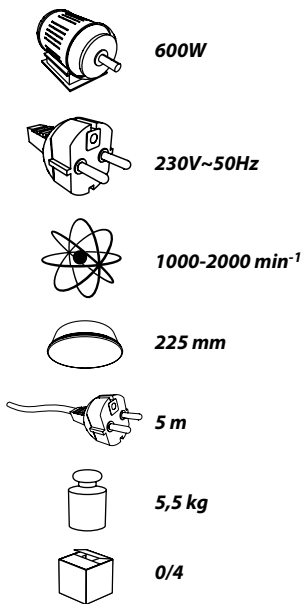

EAN 5902062592606



600W





GRAPHITE

WYRZYNARKI PILARKI SZABLOWE PILARKI TARCZOWE STRUGI NOŻE DO STUGÓW



Aluminiowa stopa o zwiększonej odporności zapobiega odkształceniom i uszkodzeniom mechanicznym.

Aluminium pad with improved strength protects against distortions and mechanical damage.

Повышенная прочность алюминиевой подошвы для предотвращения деформации и механических повреждений.

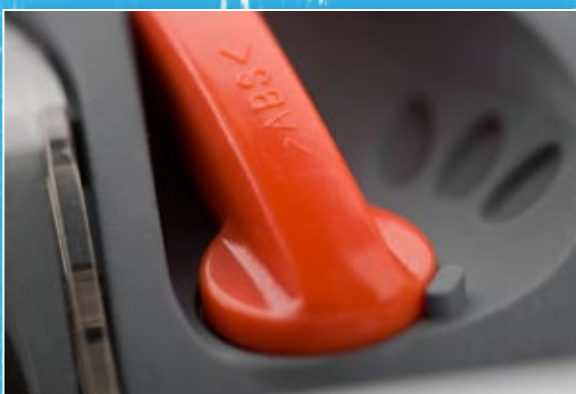

Funkcja podrzynania polega na ruchu wahadłowym brzeszczotu, w wyniku którego można uzyskać dokładniejsze cięcia bez uszkodzenia krawędzi lub powstawania zadziorów.

Pendulum function is blade pendulum-like operation that allows to achieve more precise cut without the risk of damaging the edges or burrs.

Режим маятникового хода – это подпиливание, в результате которого можно получить более точный распил, без сколов и заусениц.



Zintegrowany wskaźnik laserowy (LIF) ułatwia kontrolę dokładności wykonywanego cięcia.

Integrated laser indicator (LIF) for easier accuracy control of a cut.

Интегрированный LIF-лазер облегчает контроль точности выполняемого распила.



GRAPHITE

- **Regulacja ilości skoków brzeszczotu pozwala na dostosowanie jej do rodzaju ciętego materiału.**
- **Blade stroke speed adjustment allows to match the speed to the type of cut material.**
- **Регулировка частоты хода полотна позволяет подобрать скорость в зависимости от обрабатываемого материала.**
- **Antypoślizgowa powierzchnia rękojeści zwiększa komfort pracy.**
- **Handle anti-slip surface improves work comfort.**
- **Антискользящее покрытие рукоятки повышает комфорт работы.**
- **System odprowadzania wiórów zmniejsza zapylenie w miejscu cięcia.**
- **Shavings extraction system reduces dusts in the workplace.**
- **Система удаления стружки уменьшает запыленность на рабочем месте.**
- **Zastosowana blokada włącznika głównego załącza funkcję pracy ciągłej.**
- **Implemented main switch lock allows to turn continuous work mode on.**
- **Фиксация кнопки включения для непрерывной работы.**
- **Konstrukcja stopy wyrzynarki umożliwia regulację kąta cięcia w zakresie 0-45°.**
- **Jigsaw footplate design allows to adjust cutting angle within range 0-45°.**
- **Конструкция подошвы лобзика позволяет регулировать угол распила в диапазоне 0-45°.**



Wyrzynarka

Jigsaw • Ausschnidemaschine • Лобзик электрический • Лобзик • Dekopírfűrész • Ferástráu • Vyřezávací pila • Priamočiara pila • Vbodna žaga • Pjüklelis • Figürzágis • Jöhvsaaq • Трион зеге • Ubodna Pila • Ubodna testera • Σέα • Sierra de calar • Traforatrice • Máquina de entalhar • Scie sauteuse

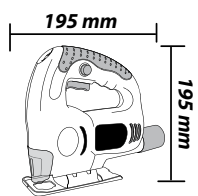
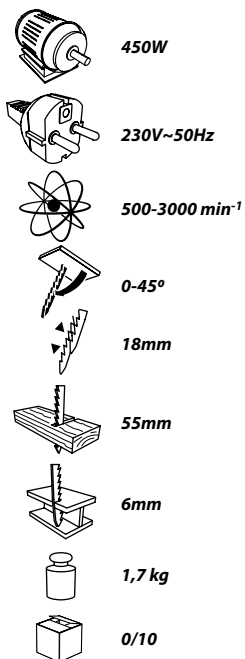

EAN 5902062580450



450W

Ref. **58G045**



Wyrzynarka

Jigsaw • Ausschnidemaschine • Лобзик электрический • Лобзик • Dekopírfűrész • Ferástráu • Vyřezávací pila • Priamočiara pila • Vbodna žaga • Pjüklelis • Figürzágis • Jöhvsaaq • Трион зеге • Ubodna Pila • Ubodna testera • Σέα • Sierra de calar • Traforatrice • Máquina de entalhar • Scie sauteuse

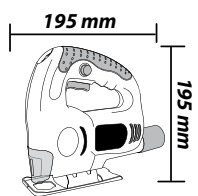
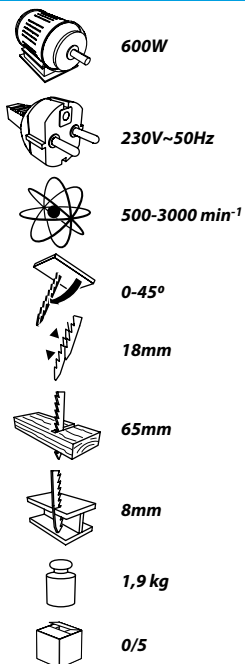

EAN 5902062580603



600W

Ref. **58G060**











Ref. **58G071**



710W



-  710W
-  230V~50Hz
-  500-3000 min⁻¹
-  0-45°
-  18mm
-  80mm
-  10mm
-  2,1 kg
-  0/5

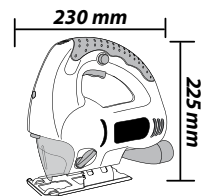







EAN 5902062580719

Ref. **58G970**

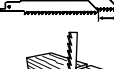

1100W



-  1100W
-  230V~50Hz
-  0-2500 min⁻¹
-  29 mm
-  180mm
-  20mm
-  3,9 kg
-  0/4

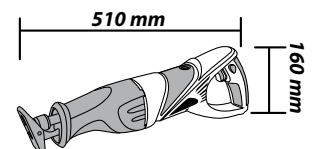

EAN 5902062589705

Pilarka tarczowa

Circular saw • Kreissäge • Пила дисковая • Пилка циркулярна • Körfűrész • Ferestrău circular • Kotoučová píla • Píla kotúčová • Krožna žaga • Diskinis pjūklas • Cirkulāržāģis • Kreissaag • Циркуляр • Kružna Píla • Kružna testera • Δισκοπλίο • Sierra circular • Segatrice a disco • Plainade disco • Scie circulaire

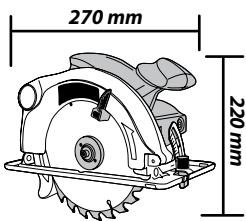
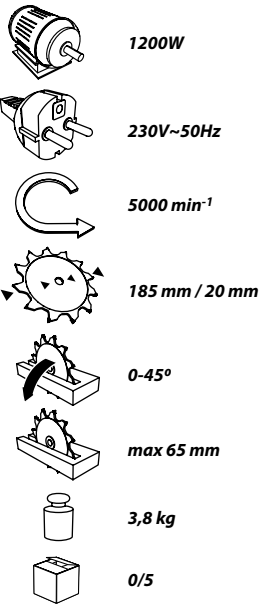

EAN 5902062584861



1200W

Ref. **58G486**



Pilarka tarczowa

Circular saw • Kreissäge • Пила дисковая • Пилка циркулярна • Körfűrész • Ferestrău circular • Kotoučová píla • Píla kotúčová • Krožna žaga • Diskinis pjūklas • Cirkulāržāģis • Kreissaag • Циркуляр • Kružna Píla • Kružna testera • Δισκοπλίο • Sierra circular • Segatrice a disco • Plainade disco • Scie circulaire

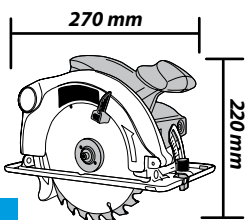
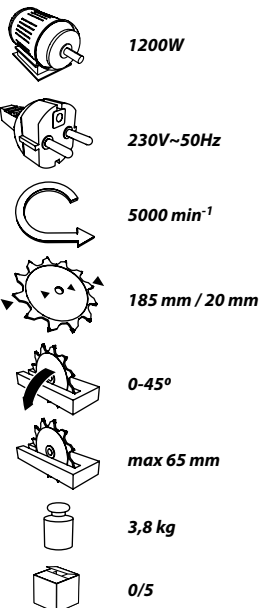

EAN 5902062584885



1200W

Ref. **58G488**



GRAPHITE

Planer • Hobel • Рубанок электрический • Гембель • Gyalugép • Gealáu • Hoblík • Hoblík elektrický • Skobeljnik • Obljus • Évele • Hőövel • Ренде • Električna blanjalica • Elektricno rende • Πλάνη • Cepillo • Pialla • Garlopa • Rabot

Strug

Ref. 59G678



850W

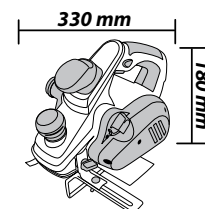
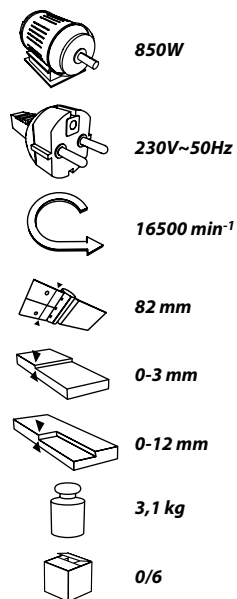

EAN 5902062596789

GRAPHITE

Planer • Hobel • Рубанок электрический • Гембель • Gyalugép • Gealáu • Hoblík • Hoblík elektrický • Skobeljnik • Obljus • Évele • Hőövel • Ренде • Električna blanjalica • Elektricno rende • Πλάνη • Cepillo • Pialla • Garlopa • Rabot

Strug

Ref. 59G679



910W

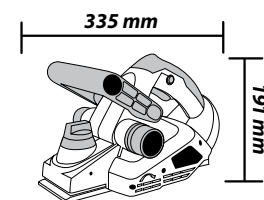
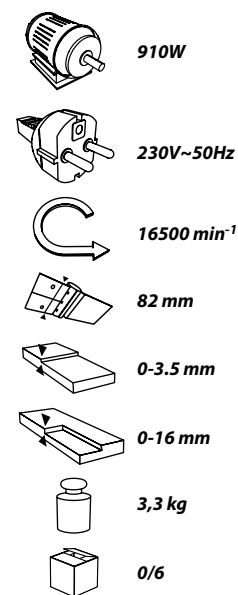

EAN 5902062596796

Nože do struga

Cutters for planer • Messer für Hobel • Ножи к рубанку • Ножи до рубанка • Gyalukések • Cuijite pentru rindea • Nože do hoblíku • Nože na hoblík • Rezila za oblič • Peilijai obliui • Èveles naži • Hõõvliterad • Ножове за ренде • Noževi za blanju • Noževi struga • Λεπίδες πλάνης • Cuchillas para cepillo eléctrico • Lame per pialla • Facas p. Garlopa • Couteaux à rabot

for: 59G678



82 mm



0/10



Ref. **59G678-30**



EAN 5902062596734



Nože do struga

Cutters for planer • Messer für Hobel • Ножи к рубанку • Ножи до рубанка • Gyalukések • Cuijite pentru rindea • Nože do hoblíku • Nože na hoblík • Rezila za oblič • Peilijai obliui • Èveles naži • Hõõvliterad • Ножове за ренде • Noževi za blanju • Noževi struga • Λεπίδες πλάνης • Cuchillas para cepillo eléctrico • Lame per pialla • Facas p. Garlopa • Couteaux à rabot

for: 59G679



82 mm



0/10



Ref. **59G679-30**



EAN 5902062221353





OPALARKI FREZARKI SZLIFIERKI STOŁOWE WIERTARKI KOLUMNOWE



Bimetalowy bezpiecznik zintegrowany z systemem grzewczym opalarki chroni urządzenie przed uszkodzeniem na skutek przegrzania.

Bimaterial cut-out fuse integrated with heating system of the hot air gun protects the tool against overheat damage.

Биметаллический предохранитель, интегрированный с нагревательной системой термофена, защищает инструмент от повреждения в результате перегрева.



Trzystopniowa regulacja temperatury oraz szybkości nawiewu umożliwia precyzyjne dostosowanie parametrów do wykonywanej pracy.

Three position temperature adjustment and airflow speed allows to match parameters precisely to the task at hand.

Трехрежимная регулировка температуры и скорости воздушного потока позволяет точно подобрать параметры в зависимости от выполняемой работы.



Konstrukcja opalarki umożliwia pracę urządzenia w pionie. W ten sposób poszerza zakres zastosowań i poprawia wygodę pracy.

Hot air gun design allows to operate the tool in vertical position, thus improving range of use and work comfort.

Конструкция термофена позволяет держать его в вертикальном положении (соплом вверх). Это расширяет сферу применения термофена и повышает комфорт работы.

GRAPHITE



Opalarka

Hotairgun • Sengmaschine • Термофен • Фен • Hőlégfúvó • Pistol de pulverizata aer cald • Opalovací stroj • Teplovzdušná pištol • prísušenstvo • Fenza vročí zrak • Techninis fenas • Fēns celtniecības • Кууаpапуhуr • Πιστολέτ за горещ въздух • Fenza vrućizrak • Fenza vreli vazduh • Πιστόλι θερμού αέρα • Decapador por aire caliente • Bruciapelo • Soprador de ar quente • Décapeur thermique

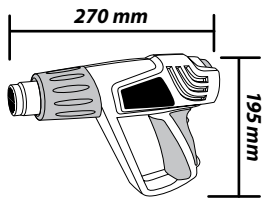
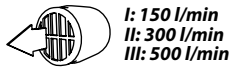
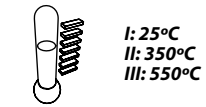

EAN 5902062595225



2000W

Ref. **59G522**

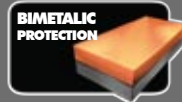

Opalarka

Hotairgun • Sengmaschine • Термофен • Фен • Hőlégfúvó • Pistol de pulverizata aer cald • Opalovací stroj • Teplovzdušná pištol • prísušenstvo • Fenza vročí zrak • Techninis fenas • Fēns celtniecības • Кууаpапуhуr • Πιστολέτ за горещ въздух • Fenza vrućizrak • Fenza vreli vazduh • Πιστόλι θερμού αέρα • Decapador por aire caliente • Bruciapelo • Soprador de ar quente • Décapeur thermique

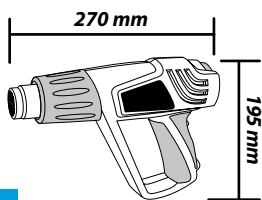
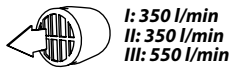

EAN 5902062595249



2000W

Ref. **59G524**

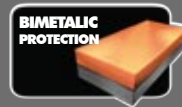

GRAPHITE

Frezarka górnwrzeczionowa







Router • Oberfräse • Станок фрезерный • Верстат фрезувальний • Felsőmaró • Traszator • Frézka horní • Fréza horná + príslušenstvo • Rezkalnik • Freza • Fréze • Profillfreespínk • Фреза • Glodalica • Glodalica • Φρέζα κοπή • Fresadora de superficie • Fresatrice con mandrino alto • Fresa de fuso superior • Fraiseuse à broche supérieure

Ref. 59G716



1500W



-  1500W
-  230V~50Hz
-  6000-26000 min⁻¹
-  6, 8, 12 mm
-  max 40 mm
-  4,9 kg
-  0/5

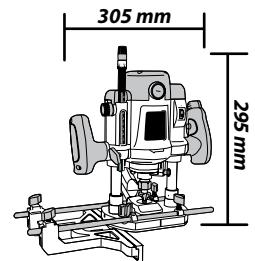

EAN 5902062597168

GRAPHITE

Szlifierka stołowa







Bench grinder • Tis Schlesifmaschine • Машина шлифовальная настольная • Шліфмашинка верстатна • Kőszörűgép • Utílaj de șlefuit • Stolní bruska • Brúška stolová • Namizni brusilnik • Stacionarus šlifuoaklis • Galda slípmášina • Lihvimispink • Шлифрел • Dvostrano točilo • Dvostrano točilo • Τροχός επιτραπέζιος • Amoladora de banco • Rettificatrice da banco • Disco de limar de mesa • Meuleuse d'établi

Ref. 59G382



250W



-  250W
-  230V~50Hz
-  2850 min⁻¹
-  150 mm / 12.7 mm
-  12V, 10W
-  8,9 kg
-  0/1

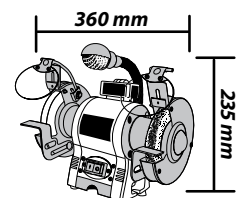

EAN 5902062593825

Szlifierka stołowa

Bench grinder • Tischschleifmaschine • Машина шлифовальная настольная • Шліфмашина верстатна • Köszörűgép • Utílaj de șlefuit
 • Stolní bruska • Brúška stolová • Namizni brusilnik • Stacionarus šlifuoškis • Galda slīrmašīna • Lihvimispink • Шмиврел • Dvostrano točilo
 • Dvostrano točilo • Τροχός επιτραπέζιος • Amoladora de banco • Rettificatrice da banco • Disco de limar de mesa • Meuleuse d'établi

GRAPHITE

Ref. **59G383**

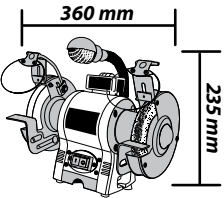
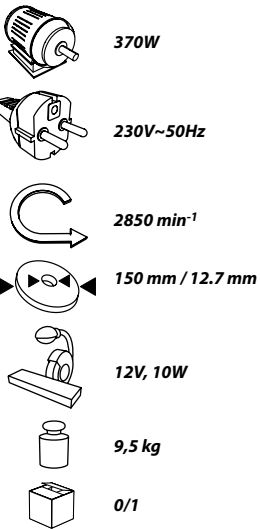

EAN 5902062593832



370W



Wiertarka kolumnowa

Drill Press • Säulenbohrmaschine • Станок сверлильный • Верстат сверлильный • Oszlopos fúrógép • Mașină de găurit montată pe coloană
 • Sloupová vrtačka • Stĺpová vrtačka • Stebrni vrtnik • Gręźimo staklės, stacionarios • Urbšanas darbgalds • Puurpink • Колонна бормашина •
 Stupna bušilica • Stubna bušilica • Κατακόρυφο βράχαιο • Taladro de columna • Trapano a colonna • Berbequim de coluna • Perceuse de colonne

GRAPHITE

Ref. **59G893**

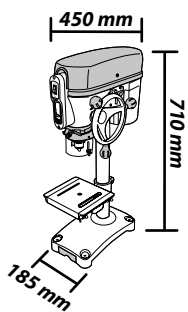
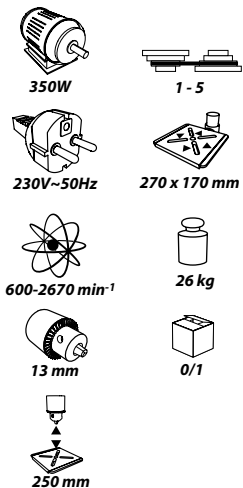

EAN 5902062598936



350W



GRAPHITE

Wiertarka kolumnowa

Drill Press • Säulenbohrmaschine • Станок сверлильный • Верстат сверлильный • Oszlopos fúrógép • Mašinã de gãurit montatã pe coloanã
 • Sloupová vrtačka • Střpová vrtačka • Stební vrtačnik • Grężimo staklės, stacionarios • Urbšanas darbgalds • Рцурpink • Колонна бормашина •
 Stupna bušilica • Stubna bušilica • Катакоруфо брãпаво • Taladro de columna • Trapano a colonna • Berbequim de coluna • Perceuse de colonne

Ref. 59G895



500W



500W

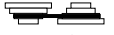

1 - 12



230V-50Hz



340 x 200 mm



425-2545 min⁻¹



40 kg



16 mm



0/1



335 mm

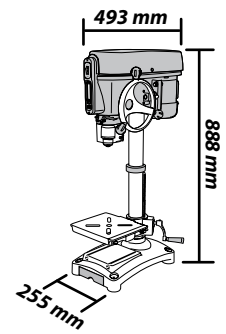

EAN 5902062598950



LASER



DEPTH CONTROL



ANGLE REGULATION



DRAWER



PILARKI UKOSOWE

PILARKI STOŁOWE

PILARKI UNIWERSALNE

TOKARKI DO DREWNA

PILARKI DO GLAZURY

ODKURZACZE WARSZTATOWE / AKCESORIA



Aluminiowa podstawa zwiększa stabilność urządzenia podczas pracy.

Aluminium base improves the tool stability during work.

Алюминиевое основание увеличивает стабильность инструмента во время работы.



Składany stół w połączeniu z kółkami ułatwia transport i przechowywanie urządzenia.

Folding work table with castors makes the tool transportation and storage easier.

Складной столик на колесиках облегчает транспортировку и хранение оборудования.

- System odprowadzania wiórów zmniejsza zapylenie w miejscach cięcia.
- Shavings extraction system reduces dusts in the workplace.
- Система удаления стружки уменьшает запыленность на рабочем месте.
- Obracany stół roboczy pozwala na zastosowanie urządzenia jako pilarki ukosowej lub stołowej.
- Rotary work table allows to use the tool as a mitre saw or a table saw.
- Поворотный рабочий столик позволяет использовать оборудование в качестве торцевой или настольной пилы.
- Obudowa i stół roboczy wykonane ze stopu aluminium.
- Body and work table are made of aluminium alloy.
- Корпус и рабочий стол выполнены из алюминия.
- Włącznik elektromagnetyczny zapewnia bezpieczeństwo użytkownika.
- Solenoid switch ensures use safety.
- Электромагнитный включатель обеспечивает безопасную работу.
- Praktyczne uchwyty na przechowanie przewodu zasilającego.
- Practical holders for power cord storage.
- Удобные фиксаторы для фиксации провода питания.
- Zestaw prowadnic ułatwia pracę.
- Guide set for easy operation.
- Набор направляющих облегчает работу.

GRAPHITE



Pilarka ukosowa

Mitre saw • Schrägsäge • Пила торцовочная • Пила-стусло • Gérvágógép • Ferestráu táiere sub inghi • Pokosová píla • Píla pokosová s laserom • Krožna žaga • Stacionarus pjúklas • Lenķa zāģis • Kaldsaag • Циркуляр • Kružna Píla • Kruzna testera • Φαλτοσπινο • Ingletadora • Segatrice per smussatura • Plaina inclinada • Scie à chanfreiner

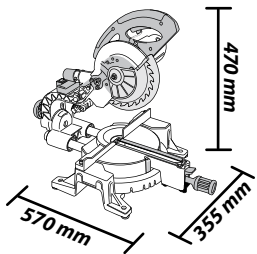
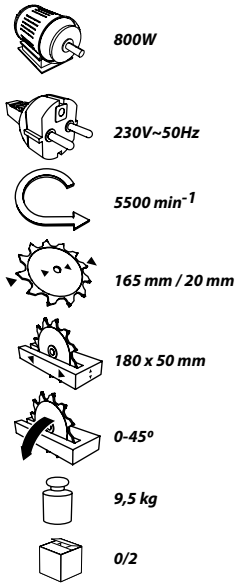

EAN 5902062598028

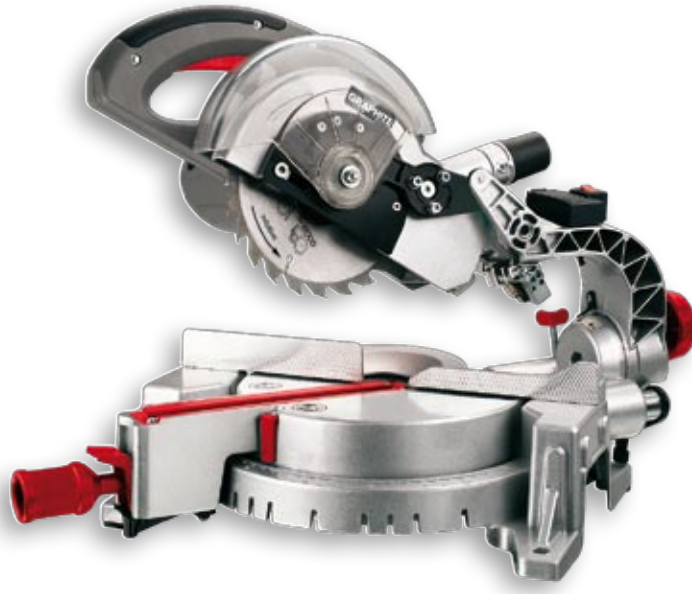

800W

Ref. **59G802**



LASER

SLIDE MOVE

45° ADJUSTABLE

ALUMINIUM BASE



Pilarka ukosowa

Mitre saw • Schrägsäge • Пила торцовочная • Пила-стусло • Gérvágógép • Ferestráu táiere sub inghi • Pokosová píla • Píla pokosová s laserom • Krožna žaga • Stacionarus pjúklas • Lenķa zāģis • Kaldsaag • Циркуляр • Kružna Píla • Kruzna testera • Φαλτοσπινο • Ingletadora • Segatrice per smussatura • Plaina inclinada • Scie à chanfreiner

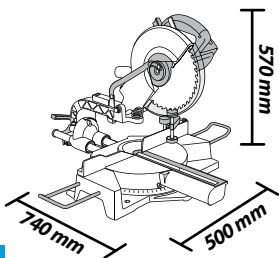
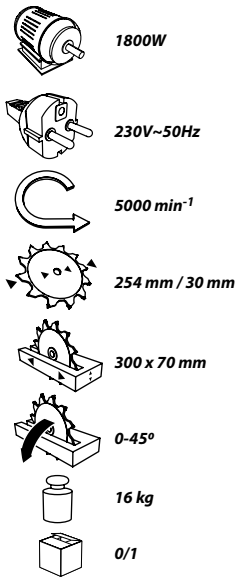

EAN 5902062598080



1800W

Ref. **59G808**



LASER

SLIDE MOVE

45° ADJUSTABLE

ALUMINIUM BASE



GRAPHITE

Table saw • Tischesäge • Пила настольная циркулярная • Пила циркулярна • Körfűrész, asztali • Mašinã de retezat cu masã • Stolní pila • Pila stolová • Namizna žaga • Stacionarus pjūklas • Galda zāģis • Lauasaag • Циркуляр • Stolna Pila • Stona testera • Επιτραπέζιο πριόνι • Sierra de mesa • Segatrice da banco • Plaina de mesa • Scie d'établi

Ref. **59G828**



800W



800W



230V~50Hz



2950 min⁻¹



200 mm / 16 mm



43 mm



0-45°



21 kg



0/1

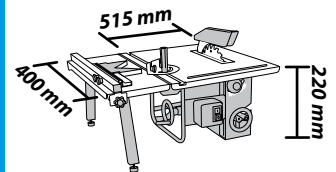

EAN 5902062598288

GRAPHITE

Table saw • Tischesäge • Пила настольная циркулярная • Пила циркулярна • Körfűrész, asztali • Mašinã de retezat cu masã • Stolní pila • Pila stolová • Namizna žaga • Stacionarus pjūklas • Galda zāģis • Lauasaag • Циркуляр • Stolna Pila • Stona testera • Επιτραπέζιο πριόνι • Sierra de mesa • Segatrice da banco • Plaina de mesa • Scie d'établi

Ref. **59G820**



1500W



1500W



230V~50Hz



5700 min⁻¹



254 mm / 30 mm



75 mm



0-45°



31 kg



0/1

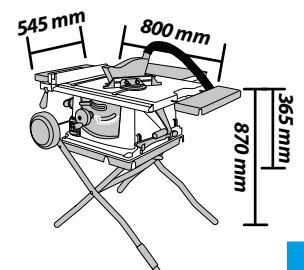

EAN 5902062598202

Pilarka uniwersalna

Flip-over saw • Universalsägemaschine • Пила универсальная • Пилка циркулярна универсална • Univerzális fűrészgép • Ferástráú universal
 • Univerzální pila • Univerzálna pila • Univerzalna mizna žaga • Universalus pjūklas • Univeršālais zāģis • Universaalsaag • Универсален трион
 • Univerzalna pila • Univerzalna testera • Διοκοπιόνο γενικής χρήσης • Sierra universal • Sega universale • Plainauniversal • Scie universelle



1400W



230V~50Hz



5000 min⁻¹



216 mm / 30 mm

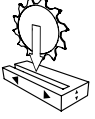

60 x 125 mm

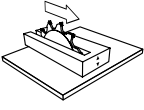

55 mm



0-45°



26 kg



0/1

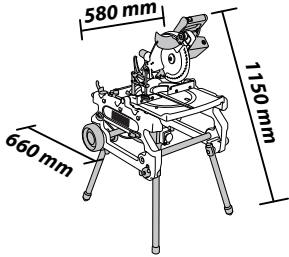

EAN 5902062598240



Ref. 59G824



1400W



GRAPHITE

Tokarka do drewna

Wood turning lathe • Holzrehmaschine • Станок токарный • Верстат токарний до обробки деревини • Faeszterga • Strung pentru lemn • Soustruh na drevo • Sústruh na drevo • Stružnica za les • Medienostekini mostaklės • Koksnes virpa • Puidutreizpink • Струг за дрвесаина • Tokarilica za drvo • Strug za drvo • Τόρνος ξύλου • Tornopara madeira • Tornio per legno • Tornop. madeira • Tour à bois



350W



230V~50Hz



500-3500 min⁻¹



SOFT START



Ø max 250 mm
max 330 mm



25 kg



0/1

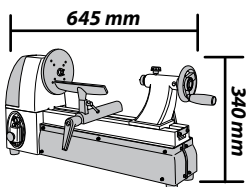

Ref. 59G735

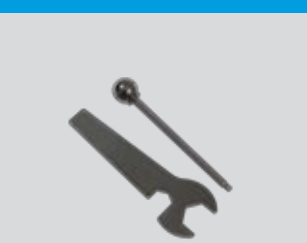

350W



Ref. **59G880**



800W



800W

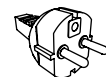

230V~50Hz



3000 min⁻¹



200 x 25,4 mm



max H 30 mm



max L 520 mm



27 kg



0/1

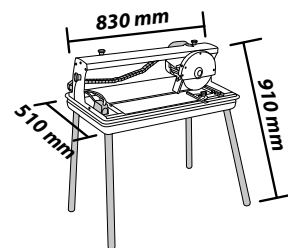

EAN 5902062598808

Ref. **59G886**



1500W



1500W

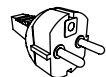

230V~50Hz



3000 min⁻¹



250 x 25,4 mm

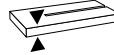

max H 60 mm



max L 620 mm



38 kg



0/1

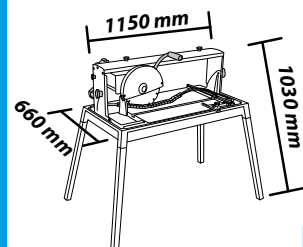

EAN 5902062598868

Odkurzacz warsztatowy

Workshop vacuum cleaner • Werkstattstaubsauger • Пылесос промышленный • Пылесос профессиональный • Műhelypororszívó • Aspirator atelier cu sistem vacuum • Dřelenský vysavač • Dielenský vysávač • Industrijski sesalnik • Pramoninis siurblys • Rūpniecības putekļsūcājs • Tööstuslik tolmuimeja • Промышленна прашосмукачка • Radionički usisivač • Industrijski usisivač • Ηλεκτρική οκούλα επαγγελματική • Aspirador • Aspirador polvo da oficina • Aspirador de oficina • Aspirateur d'atelier

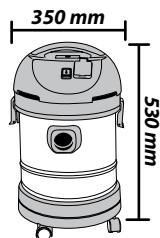
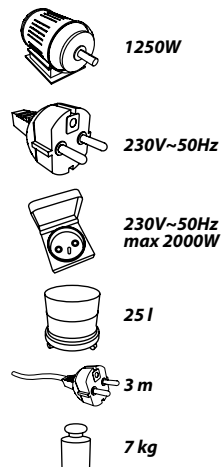

EAN 5902062596062



1250W

Ref. **59G606**



Worki papierowe

Paper bags • Papierbeutel • Мешки бумажные • Мішки паперові • Papírsákok • Sáci de hárte • Papírové pytle • Papierové vrecúška • Papierne vreče • Popieriniai maišėliai • Papira maisi • Paberkotid • Книжнич торби • Papirnete vreče • Papirne kese • Χάρτινοι σάκοι • Bolsas de papel • Sacchetti di carta • Sacos de papel • Sacs de papier

for: 59G606



x5



0/1

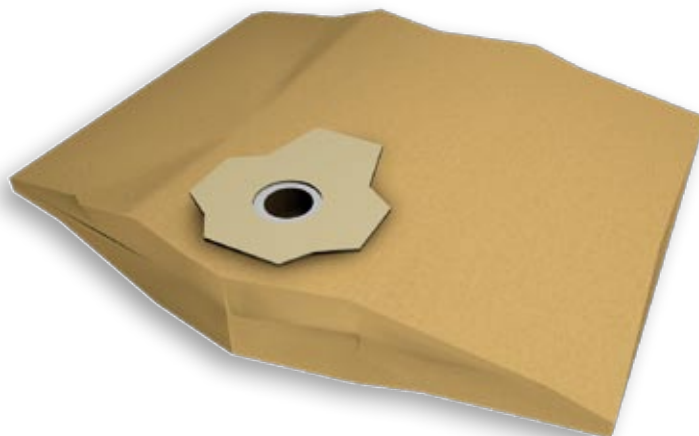

GRAPHITE

Ref. **59G606-145**

Ref. **59G606-146**



for: **59G606**



x1



0/1

EAN 5902062468208

Ref. **59G606-147**



for: **59G606**



4 m



0/1

EAN 5902062221476

AGREGATY PRĄDOTWÓRCZE

PILARKI ŁAŃCUCHOWE / AKCESORIA

MYJKI CIŚNIENIOWE / AKCESORIA

POMPY ZANURZENIOWE



Czujnik poziomu oleju zabezpiecza silnik spalinowy przed uszkodzeniem.

Oil level sensor protects combustion engine against damage.

Датчик уровня масла предохраняет двигатель от повреждения.



System stabilizacji napięcia AVR.

Voltage stabilizing system AVR.

Система стабилизации напряжения AVR.

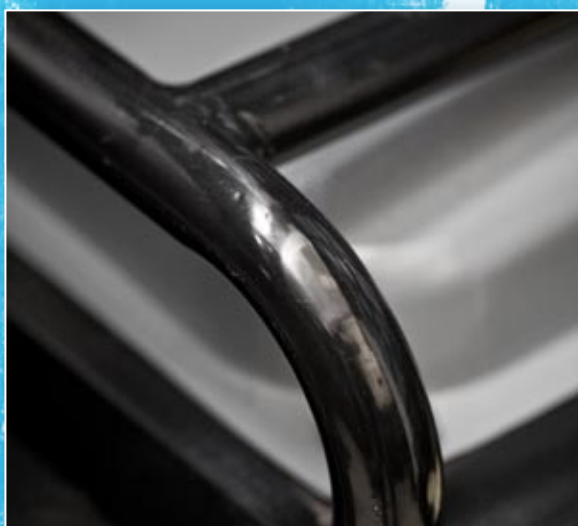

Stelaż ochronny zabezpieczający przed uszkodzeniami mechanicznymi.

Protection frame against mechanical damage.

Защитная рама предохраняет от механических повреждений.



GRAPHITE



Pilarka łańcuchowa

Chain saw • Kettensägemaschine • Пила цепная электрическая • Пилка ланцюгова • Lánccűrész • Ferástráú cu lanț • Retézová pila • Refázová pila • Verižna žaga • Grandininis pjūkļas • Kēdes zāģis • Kettisaag • Верижен трион • Lančana pila • Lančana testera • Ηλεκτρικό αλυσοπριονο • Sierra de cadena • Segá a catena • Pláina de corrente • Scie à chaîne



0,9kW/1.22KM



25,4 cm³



3500 - 10000 min⁻¹



305 mm / 12"



230 ml



0,8 l/h



0,375" (9,53 mm)



3,1 kg



0/2

525 mm

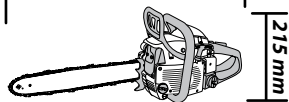

215 mm

EAN 5902062589415



Ref. **58G941**

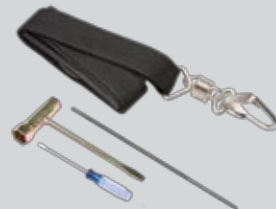

0,9 kW / 1,22 KM



Pilarka łańcuchowa

Chain saw • Kettensägemaschine • Пила цепная электрическая • Пилка ланцюгова • Lánccűrész • Ferástráú cu lanț • Retézová pila • Refázová pila • Verižna žaga • Grandininis pjūkļas • Kēdes zāģis • Kettisaag • Верижен трион • Lančana pila • Lančana testera • Ηλεκτρικό αλυσοπριονο • Sierra de cadena • Segá a catena • Pláina de corrente • Scie à chaîne



2.0kW/2.7KM



43 cm³



3000 - 10000 min⁻¹



455 mm / 18"



510 ml



1,2 l/h



0,375" (9,53 mm)



6 kg



0/1

860 mm

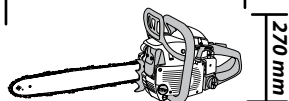

270 mm

EAN 5902062589477



Ref. **58G947**

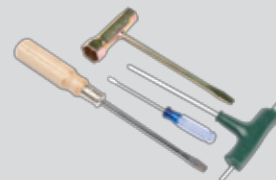

2,0 kW / 2,7 KM



GRAPHITE

Łańcuch do pilarki łańcuchowej

Chain for chain saw • Kettensägekette • Цепь для цепной пилы • Ланцюг до пилки ланцюгової • Lánčfűrész lánc • Lanč p/u ferástráu cu lanč • Řetěz řetězové pily • Veriga za verižno žago • Grandiné grandininiám pjučkui • Kėde kėžu zągim • Kettšae kett • Lanac za elektrícnu testera • Αλυσίδα • Cadena para sierra de cadena • Catena per sega a catena • Corrente para serra de motor • Chaîne pour scie à chaîne

Ref. **58G941-71**



for: **58G941**

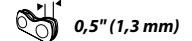
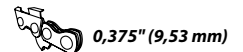

EAN 5902062469076

GRAPHITE

Prowadnica do pilarki łańcuchowej

Chain saw bar • Kettensägeführung • Направляющий стержень для цепной пилы • Стрижень направляющий до пилки ланцюгової • Lánčvezető lánčfűrészhéz • Ghidajp/ł ferástráu cu lanč • Vodící lišta řetězové pily • Vodíaca lišta reťazovej pily • Vodilo verige za verižno žago • Kreipiančioji grandininiám pjučkui • Vadikla kėdes zągim • Kettšae saetera • Шина за верижен трион • Vodilica za lančanu pilu • Vodica za lančanu testeru • Καθοδηγητικό για αλυσοπίριο • Bomba de suersión para agua sucia • Guida per catena • Guias de motoserra • Guidage pour scie à chaîne

Ref. **58G941-73**



for: **58G941**

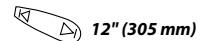

EAN 5902062469083

GRAPHITE

Łańcuch do pilarki łańcuchowej

Chain for chain saw • Kettensägekette • Цепь для цепной пилы • Ланцюг до пилки ланцюгової • Lánčfűrész lánc • Lanč p/u ferástráu cu lanč • Řetěz řetězové pily • Veriga za verižno žago • Grandiné grandininiám pjučkui • Kėde kėžu zągim • Kettšae kett • Lanac za elektrícnu testera • Αλυσίδα • Cadena para sierra de cadena • Catena per sega a catena • Corrente para serra de motor • Chaîne pour scie à chaîne

Ref. **58G947-71**



for: **58G947**

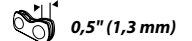
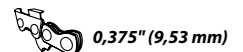

EAN 5902062222220

GRAPHITE

Prowadnica do pilarki łańcuchowej

Chain for chain saw • Kettensägekette • Цепь для цепной пилы • Ланцюг до пилки ланцюгової • Lánčfűrész lánc • Lanč p/u ferástráu cu lanč • Řetěz řetězové pily • Veriga za verižno žago • Grandiné grandininiám pjučkui • Kėde kėžu zągim • Kettšae kett • Lanac za elektrícnu testera • Αλυσίδα • Cadena para sierra de cadena • Catena per sega a catena • Corrente para serra de motor • Chaîne pour scie à chaîne

Ref. **58G947-73**



for: **58G947**

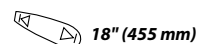

EAN 5902062222213

Agregat prądowórczy

Electric generator • Stromeerzeugungsgagregat • Электрогенератор бензиновый • Электрогенератор бензиновый • Áramfejlesztő • Grup electrogen/generator • Elektrický agregát • Prúdový agregát • Električni generator • Generatorius • Benzina elektrogenerator • Voolutootmisseade • Электрически агрегат • Agregat za struju • Naponski generator • Γεννήτρια βενζίνης • Grupo electrógeno • Gruppo elettrogeno • Gerador de eletricidade • Groupe électrogène

GRAPHITE

Ref. **58G903**



2000W



max 2300W



230V~50Hz



12V



4.78kW/6.5KM



1.25 l/h



196 cm³



95dB



3000 min⁻¹



42 kg



15 l



0/1



2000W

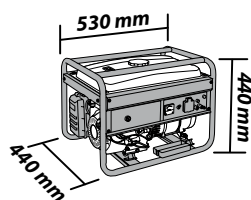

EAN 5902062589033



Akumulator

Battery • Akkumulator • Аккумулятор • Аккумулятор • Akkumulátor • Acumulator • Akumulátor • Akumulátor • Akumulator • Akumulátorius • Akumulators • Aku • Аккумулятор • Akumulator • Akumulator • Ηλεκτρικός συσσωρευτής • Bateria • Accumulatore • Bateria • Batterie

GRAPHITE

Ref. **58G903-12**

for: 58G903



12V 230V~50Hz



7.0Ah



Pb-Wet, MF



0/1

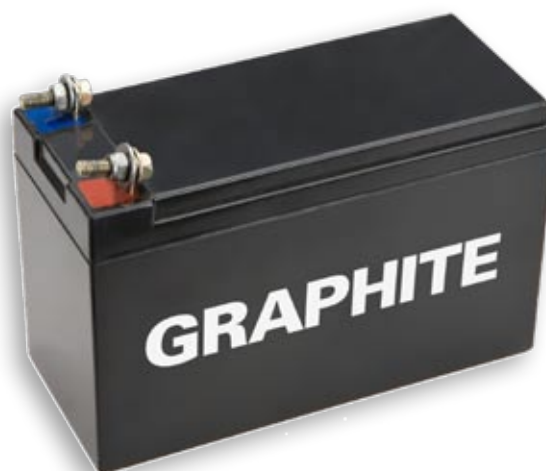

12V

EAN 5902062229038

GRAPHITE

Myjka ciśnieniowa

High pressure cleaner • Druckreiniger • Мойка высокого давления • Мийка під тиском • Magasnyomású mosó • Mašíná de spálat sub presíune • Vysokotlaký čistič • Tlaková vodná čistička • Visokotlačni čistilec • Sláginis indas • Augstspiediena mazgātne • Survepesur • Mivka pod nalyaganē • Tlačni čistač • Čistač pod pritiskom • Πιεστικό • Limpiadora de presión • Idropulitrice • Máquina de lavar por pressão • Nettoyeur haute pression

Ref. **59G414**



2500W

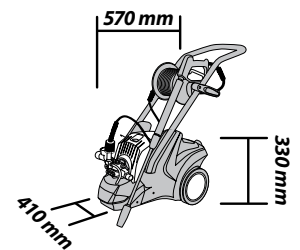
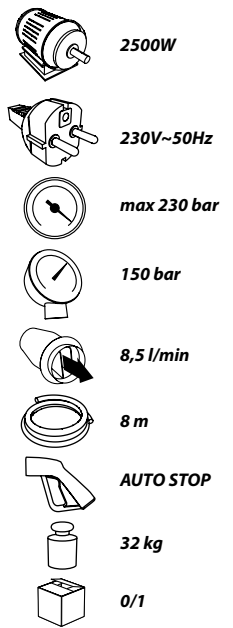

EAN 5902062594143

GRAPHITE

Lanca z rękojeścią pistoletową

Lance with gun handle • Lanze mit dem Pistolengriff • Удлинительная штанга с соплом и пистолетом • Πίκα з пістолетним руків'ям • Szórószer pístolymarkolattal • Lance cu mánier de pistol • Násadec s rukojetí pistole • Dýza s pístolovou rukoväťou • Šoba s pístolnim ročajem • Jungtis su pístoleto rankena • Asmens ar pístoles rokturi • Pústolkäepidemega piik • Копие с пистолетна дръжка • Lanca sa drškom za pistolj • Lula sa pistolj drškom • Μπάρα προέκτασης με ακροφύσιο και πιστόλι • Lanca con mango de pistola

Ref. **59G414-75**



for: **59G414**



0/1

EAN 5902062469366

Lanca Turbo

Turbo lance • Turbo-Lanze • Удлинительная штанга с соплом turbo • Турбопика • Turbó szórószer • Lance turbo • Násadec turbo • Dýza turbo • Turbo šoba • Jungtis „turbo“ • Asmenis turbo • Turbopik • Копие турбо • Lanca turbo • Turbo lula • Μπάρα προέκτασης με ακροφύσιο turbo • Lanca turbo

Ref. **59G414-174**



for: **59G414**



0/1

EAN 5902062469359

Szczotka rotacyjna

Rotating brush • Drehbürste • Щетка ротационная • Щітка ротаційна • Rotációs kefe • Perie rotativă • Rotační kartáč • Rotačná kefka • Rotacijska krtača • Rotacinis šepetys • Rotējoša birste • Röördhari • Ротационна четка • Rotacijska četka • Rotaciona četka • Περιτροφική βούρτσα • Cepillo rotatorio

Ref. **59G414-173**



for: **59G414**



0/1

EAN 5902062469342

Pompa zanurzeniowa

Submersible pump • Tauchpumpe • Погружной насос • Pompa załębna • Búvárszivattyú • Pompă de cufundare • Ponorné čerpadlo • Ponorné čerpadlo • Роторна črpalka • Ránardínamas siurblys • Iegremdējamašis sūkņš • Sukelpump • Подводна помпа • Роторна pumpa • Potorpljena pumpa • Καταβύμενη αντλία • Bomba de inmersión • Pompa a immissione • Bomba de imersão • Pompe immergée

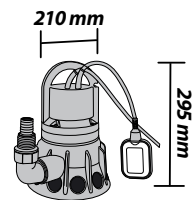
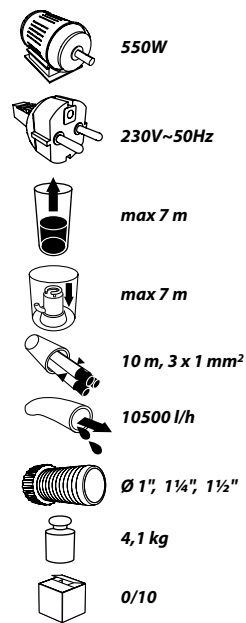

EAN 5902062594426



550W

Ref. 59G442



Pompa zanurzeniowa

Submersible pump • Tauchpumpe • Погружной насос • Pompa załębna • Búvárszivattyú • Pompă de cufundare • Ponorné čerpadlo • Ponorné čerpadlo • Роторна črpalka • Ránardínamas siurblys • Iegremdējamašis sūkņš • Sukelpump • Подводна помпа • Роторна pumpa • Potorpljena pumpa • Καταβύμενη αντλία • Bomba de inmersión • Pompa a immissione • Bomba de imersão • Pompe immergée

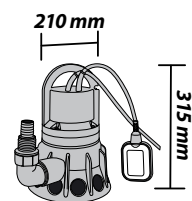
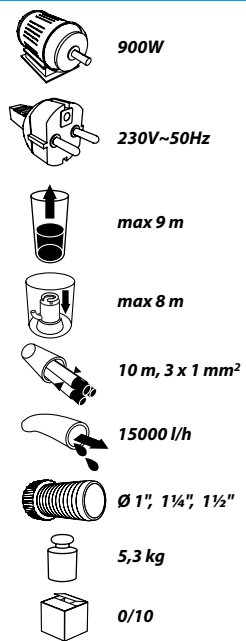

EAN 5902062594440



900W

GRAPHITE

Ref. 59G444



GRAPHITE

Pompa zanurzeniowa

Submersible pump • Tauchpumpe • Погружной насос • Pompa załgibna • Búvárszivattyú • Pompă de cufundare • Ponorné čerpadlo • Ponorné čerpadlo • Potopna črpalka • Panardinamas siurblys • Įegremdėjamaís sūkniis • Sukelpump • Подводна помпа • Potopna pumpa • Potopljena pumpa • Καταδύομενη αντλία • Bomba de inmersión • Pompa a immersione • Bomba de imersão • Pompe immergée

Ref. **59G446**



650W



650W



230V~50Hz



max 7.5 m



max 7 m



10 m, 3 x 1 mm²



11500 l/h



Ø 2", 1½"



7,8 kg



0/10

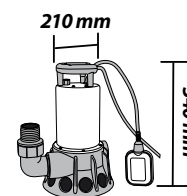

EAN 5902062594464

GRAPHITE

Pompa zanurzeniowa

Submersible pump • Tauchpumpe • Погружной насос • Pompa załgibna • Búvárszivattyú • Pompă de cufundare • Ponorné čerpadlo • Ponorné čerpadlo • Potopna črpalka • Panardinamas siurblys • Įegremdėjamaís sūkniis • Sukelpump • Подводна помпа • Potopna pumpa • Potopljena pumpa • Καταδύομενη αντλία • Bomba de inmersión • Pompa a immersione • Bomba de imersão • Pompe immergée

Ref. **59G449**



900W



900W



230V~50Hz



max 9 m



max 8 m



10 m, 3 x 1 mm²



17000 l/h



Ø 2", 1½"



7,8 kg



0/10

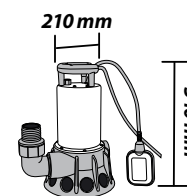

EAN 5902062594495

AKCESORIA



ACCESSORIES

AKCESORIA

ZUBENÖR

ПРИНАДЛЕЖНОСТИ

ПРИНАЛЕЖНОСТІ

TARTOZÉKOK

ACCESORII

PŘÍSLUŠENSTVÍ

PRÍSLUŠENSTVO

PRIBOR

PRIEDAI

AKSESUĀRI

TARVIKUD

AKCESOAPI

PRIBOR

PRIBOR

ΕΞΑΡΤΗΜΑΤΑ

ACCESORIOS





Wiertła do metalu

Metal drills • Metallbohrer • Сверла по металлу • Сверла по металлу • Fémfúró • Burghie pentru metale • Vrtáky do kovu • Vrtáky do kovu • Svedri za kovino • Gražtal metalui • Uribis metalam • Metallpuur • Сврла за метал • Svrdla za metal • Burgija za metal • Τρυπάνια μετάλλου • Brocas para metal • Punte per metallo • Brocas p. metal • Forêts à métal

GRAPHITE

Ref.	Ø[mm]	L1	L2	EAN	Box
57H005	0.5	5	22	5902062570055	20/200
57H008	0.8	5	30	5902062570086	20/200
57H010	1.0	5	34	5902062570109	20/200
57H012	1.5	5	40	5902062570123	20/200
57H014	2.0	5	49	5902062570147	20/200
57H015	2.2	3	53	5902062570154	20/200
57H016	2.4	3	57	5902062570161	20/200
57H018	2.5	3	57	5902062570185	20/200
57H020	3.0	1	61	5902062570208	20/200
57H021	3.1	1	65	5902062570215	20/200
57H022	3.2	1	65	5902062570222	20/200
57H023	3.5	1	70	5902062570239	20/200
57H027	3.8	1	75	5902062570277	20/200
57H024	4.0	1	75	5902062570246	20/200
57H025	4.1	1	75	5902062570253	20/200
57H026	4.2	1	75	5902062570260	20/200
57H028	4.5	1	80	5902062570284	20/200
57H030	4.8	1	86	5902062570307	20/200
57H032	5.0	1	86	5902062570321	20/200
57H033	5.1	1	86	5902062570338	20/200
57H034	5.2	1	86	5902062570345	20/200
57H036	5.5	1	93	5902062570369	20/200
57H038	6.0	1	93	5902062570383	20/200
57H039	6.1	1	101	5902062570390	20/200
57H041	6.2	1	101	5902062570413	20/200
57H040	6.5	1	101	5902062570406	20/200
57H042	7.0	1	109	5902062570420	20/200
57H044	7.5	1	109	5902062570444	20/200
57H046	8.0	1	117	5902062570468	20/200
57H047	8.1	1	117	5902062570475	20/200
57H049	8.2	1	117	5902062570499	20/200
57H048	8.5	1	117	5902062570482	20/200
57H050	9.0	1	125	5902062570505	20/200
57H052	9.5	1	125	5902062570529	20/200
57H054	10.0	1	133	5902062570543	20/200
57H055	10.2	1	133	5902062570550	20/200
57H056	10.5	1	133	5902062570567	20/200
57H058	11.0	1	142	5902062570581	20/200
57H060	11.5	1	142	5902062570604	20/200
57H062	12.0	1	151	5902062570628	20/200
57H064	12.5	1	151	5902062570642	20/200
57H066	13.0	1	151	5902062570666	20/200
57H068	14.0	1	160	5902062570680	10/100
57H070	15.0	1	169	5902062570703	10/100
57H072	16.0	1	178	5902062570727	10/100
57H074	18.0	1	191	5902062570741	10/100
57H076	20.0	1	205	5902062570765	10/100
57H005-10	0.5	10	22	5902062222251	50/1000
57H008-10	0.8	10	30	5902062222268	50/1000
57H010-10	1.0	10	34	59020622221919	50/1000
57H012-10	1.5	10	40	59020622221926	20/600
57H014-10	2.0	10	49	59020622221933	20/600
57H015-10	2.2	10	53	5902062222275	20/600
57H016-10	2.4	10	57	59020622221940	20/400
57H018-10	2.5	10	57	59020622221957	20/400
57H020-10	3.0	10	61	59020622221964	20/400
57H021-10	3.1	10	65	5902062222282	20/200
57H022-10	3.2	10	65	59020622221971	20/200
57H023-10	3.5	10	70	59020622221988	20/200
57H027-10	3.8	10	75	5902062222299	20/200
57H024-10	4.0	10	75	59020622221995	20/200

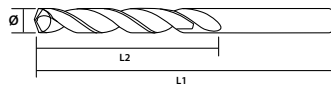

Ref.	Ø[mm]	L1	L2	EAN	Box
57H025-10	4.1	10	75	5902062222305	20/200
57H026-10	4.2	10	75	5902062222008	20/200
57H028-10	4.5	10	80	5902062222015	20/200
57H030-10	4.8	10	86	5902062222022	10/100
57H032-10	5.0	10	86	5902062222039	10/100
57H033-10	5.1	10	86	5902062222312	10/100
57H034-10	5.2	10	86	5902062222046	10/100
57H036-10	5.5	10	93	5902062222053	10/100
57H038-10	6.0	10	93	5902062222060	10/100
57H039-10	6.1	10	101	5902062222329	10/100
57H041-10	6.2	10	101	5902062222336	10/100
57H040-10	6.5	10	101	5902062222077	10/100
57H042-10	7.0	10	109	5902062222084	5/50
57H044-10	7.5	10	109	5902062222091	5/50
57H046-5	8.0	5	117	5902062222107	10/50
57H047-5	8.1	5	117	5902062222343	10/50
57H049-5	8.2	5	117	5902062222350	10/50
57H048-5	8.5	5	117	5902062222114	10/50
57H050-5	9.0	5	125	5902062222121	10/50
57H052-5	9.5	5	125	5902062222138	10/50
57H054-5	10.0	5	133	5902062222145	10/50
57H055-5	10.2	5	133	5902062222367	10/50
57H056-5	10.5	5	133	5902062222152	10/50
57H058-5	11.0	5	142	5902062222169	10/40
57H060-5	11.5	5	142	5902062222176	10/40
57H062-5	12.0	5	151	5902062222183	10/40
57H064-5	12.5	5	151	5902062222190	10/40
57H066-5	13.0	5	151	5902062222206	10/40
57H068-3	14.0	3	160	5902062222374	5/20
57H070-3	15.0	3	169	5902062222381	5/20
57H072-3	16.0	3	178	5902062222398	5/20
57H074-3	18.0	3	191	5902062222404	5/20
57H076-3	20.0	3	205	5902062222411	5/20



DIN338



HSS Co 5%



Wiertła do metalu

Metal drills • Metallbohrer • Сверла по металлу • Сверла по металлу • Fémfúró • Burghie pentru metale • Vrtáky do kovu • Vrtáky do kovu • Svedri za kovino • Gražtal metalui • Uribis metalam • Metallpuur • Сврла за метал • Svrdla za metal • Burgija za metal • Τρυπάνια μετάλλου • Brocas para metal • Punte per metallo • Brocas p. metal • Forêts à métal

GRAPHITE

Ref.	Ø[mm]	Box	EAN	Box
57H088	1.5 - 6.5	13	5902062570888	5/20
57H089	1.0 - 10	19	5902062570895	5/20
57H090	1.0 - 13.0	25	5902062570901	5/20

Tabela prędkości wiercenia:

Ø [mm]	STAL/STAL [min ⁻¹]	INOX [min ⁻¹]
1.0-2.0	4770	1000
2.1-2.5	3800-4500	800-1000
2.6-3.0	3200-3650	600-800
3.1-3.5	2700-3100	600-800
3.6-4.0	2400-2650	500-600
4.1-4.5	2000-2200	400-500
4.6-5.0	1800-1950	300-400
5.1-6.0	1600-1750	300-400
6.1-8.0	1100-1450	250-300
8.1-10.0	1000-1100	200-300
10.1-12.0	750-900	150-200
12.1-14.0	650-750	120-150



DIN338



HSS Co 5%



GRAPHITE

Wierła do metalu
Metal drills • Metallbohrer • Сверла по металлу • Сверла по металу • Fémfúró • Burghie pentru metale • Vrtáky do kovu • Vrtáky do kovu • Svedri za kovino • Gražtai metalui • Urbis metalām • Metallpuur • Сврла за метал • Svrdla za metal • Burgija za metal • Τρυπάνια μετάλλου • Brocas para metal • Punte per metallo • Brocas p. metal • Forêts à métal

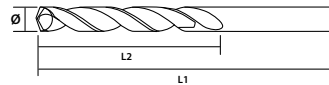

Ref.	Ø[mm]		L1	L2	EAN	
57H105	0.5	5	22	6	5902062571052	20/200
57H108	0.8	5	30	10	5902062571083	20/200
57H110	1.0	5	34	12	5902062571106	20/200
57H112	1.5	5	40	18	5902062571120	20/200
57H114	2.0	5	49	24	5902062571144	20/200
57H115	2.2	3	53	27	5902062571151	20/200
57H116	2.4	3	57	30	5902062571168	20/200
57H118	2.5	3	57	30	5902062571182	20/200
57H120	3.0	1	61	33	5902062571205	20/200
57H121	3.1	1	65	36	5902062571212	20/200
57H122	3.2	1	65	36	5902062571229	20/200
57H123	3.5	1	70	39	5902062571236	20/200
57H127	3.8	1	75	43	5902062571274	20/200
57H124	4.0	1	75	43	5902062571243	20/200
57H125	4.1	1	75	43	5902062571250	20/200
57H126	4.2	1	75	43	5902062571267	20/200
57H128	4.5	1	80	47	5902062571281	20/200
57H130	4.8	1	86	52	5902062571304	20/200
57H132	5.0	1	86	52	5902062571328	20/200
57H133	5.1	1	86	52	5902062571335	20/200
57H134	5.2	1	86	52	5902062571342	20/200
57H136	5.5	1	93	57	5902062571366	20/200
57H138	6.0	1	93	57	5902062571380	20/200
57H139	6.1	1	101	63	5902062571397	20/200
57H141	6.2	1	101	63	5902062571410	20/200
57H140	6.5	1	101	63	5902062571403	20/200
57H142	7.0	1	109	69	5902062571427	20/200
57H144	7.5	1	109	69	5902062571441	20/200
57H146	8.0	1	117	75	5902062571465	20/200
57H147	8.1	1	117	75	5902062571472	20/200
57H149	8.2	1	117	75	5902062571496	20/200
57H148	8.5	1	117	75	5902062571489	20/200
57H150	9.0	1	125	81	5902062571502	20/200
57H152	9.5	1	125	81	5902062571526	20/200
57H154	10.0	1	133	87	5902062571540	20/200
57H155	10.2	1	133	87	5902062571557	20/200
57H156	10.5	1	133	87	5902062571564	20/200
57H158	11.0	1	142	94	5902062571588	20/200
57H160	11.5	1	142	94	5902062571601	20/200
57H162	12.0	1	151	101	5902062571625	20/200
57H164	12.5	1	151	101	5902062571649	20/200
57H166	13.0	1	151	101	5902062571663	20/200
57H168	14.0	1	160	108	5902062571687	10/100
57H170	15.0	1	169	114	5902062571700	10/100
57H172	16.0	1	178	120	5902062571724	10/100
57H174	18.0	1	191	130	5902062571748	10/100
57H176	20.0	1	205	140	5902062571762	10/100

DIN338



HSS
TIN

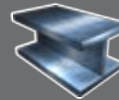

GRAPHITE

Wierła do metalu
Metal drills • Metallbohrer • Сверла по металлу • Сверла по металу • Fémfúró • Burghie pentru metale • Vrtáky do kovu • Vrtáky do kovu • Svedri za kovino • Gražtai metalui • Urbis metalām • Metallpuur • Сврла за метал • Svrdla za metal • Burgija za metal • Τρυπάνια μετάλλου • Brocas para metal • Punte per metallo • Brocas p. metal • Forêts à métal



Ref.	Ø[mm]		EAN	
57H198	1.5 - 6.5	13	5902062571984	5/20
57H199	1.0 - 10	19	5902062571991	5/20
57H200	1.0 - 13.0	25	5902062572004	5/20

DIN338



HSS
TIN

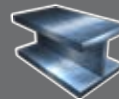

Wiertła uniwersalne

Universal drill • Allzweckbohrer • Сверло универсальное • Сверло универсальное • Univerzális fűrészárn • Burghie universal • Univerzální vrták • Univerzálny vrták • Univerzalni sveder • Universalis grăţtas • Universālais urbis • Univerzālpuur • Универсально сверло • Univerzalno svrdlo • Univerzalna burgilja • Τριπλών γενικής χρήσης • Broca universal • Punta universale • Broca universal • Foret universels

Ref.	Ø[mm]	L1	L2	EAN	
57H302	4	75	40	5902062573025	50/400
57H303	5	80	50	5902062573032	50/400
57H304	6	100	60	5902062573049	50/400
57H305	7	100	60	5902062573056	50/400
57H306	8	120	80	5902062573063	50/400
57H307	10	120	80	5902062573070	50/400
57H308	12	150	85	5902062573087	50/400

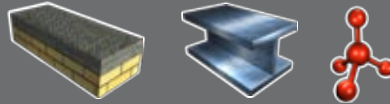
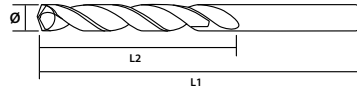

GRAPHITE

Wiertła do betonu

Concrete drills • Betonbohrer • Сверла по бетону • Сверла по бетону • Betonfűró • Burghie pentru beton • Vrtáky do betonu • Vrtáky do betónu • Svedri za beton • Graţţai betonui • Betona urbji • Betoónipuur • Средла за бетон • Svrdlo za beton • Burgije za beton • Τριπλών για µετό • Brocas para hormigón • Punte per calcestruzzo • Brocas. Betão • Forêts pour béton/béton

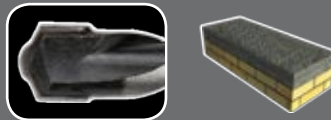
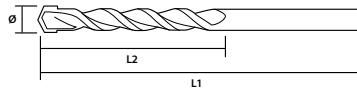

Ref.	Ø[mm]	L1	L2	EAN	
57H312	4	75	40	5902062573124	1/500
57H314	6	100	60	5902062573148	1/700
57H316	8	110	80	5902062573162	1/600
57H318	10	120	80	5902062573186	1/400
57H320	12	150	85	5902062573209	1/200
57H322	14	150	85	5902062573223	1/200
57H324	16	160	90	5902062573247	1/170
57H326	18	160	90	5902062573261	1/100
57H328	20	160	100	5902062573285	1/80
57H330	6	150	135	5902062573308	1/500
57H332	8	150	135	5902062573322	1/250
57H334	10	250	135	5902062573346	1/200
57H336	12	250	135	5902062573360	1/160
57H338	14	250	135	5902062573384	1/100
57H340	8	400	230	5902062573407	1/150
57H342	10	400	230	5902062573421	1/150
57H344	10	600	400	5902062573445	1/100
57H346	12	600	400	5902062573469	1/60



GRAPHITE

Wiertła do betonu

Concrete drills • Betonbohrer • Сверла по бетону • Сверла по бетону • Betonfűró • Burghie pentru beton • Vrtáky do betonu • Vrtáky do betónu • Svedri za beton • Graţţai betonui • Betona urbji • Betoónipuur • Средла за бетон • Svrdlo za beton • Burgije za beton • Τριπλών για µετό • Brocas para hormigón • Punte per calcestruzzo • Brocas. Betão • Forêts pour béton/béton

Ref.	Ø[mm]	L1	L2		EAN	
57H350	4	75	40	5	5902062573506	1/100
	5	80	50			
	6	100	60			
	8	120	80			
	10	120	80			

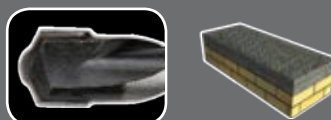
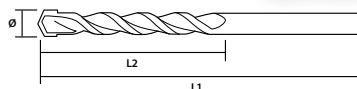

GRAPHITE

Wiertło do szkła

Glass drill • Glasbohrer • Свекло по стеклу • Сверло по стеклу • Üvegűró • Burghiu pentru sticlă • Vrták do skla
• Vrták do skla • Sveder za steklo • Grážal stiklam • Klaaspuur • Свекло за стькно • Svrldo za staklo • Burgija za staklo • Τρυπάνι για σκίο • Broca para vidrio • Punta per vetro • Broca p. Vidro • Foret à verre

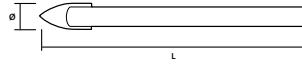

Ref.	Ø[mm]	L	EAN	
57H260	5	70	5902062572608	10/50
57H261	6	75	5902062572615	10/50
57H262	8	80	5902062572622	10/50
57H263	10	85	5902062572639	10/50

GRAPHITE

Wiertła diamentowe

Diamond drill • Diamantbohrer • Свекло алмазное • Сверло алмазное • Gyémántűró • Burghiu diamentat • Diamantový vrták
• Diamantový vrták • Diamantno steklo • Deimantinis grąžtas • Dimanta urbis • Teemantpuur • Диамантено свекло • Dijamantno svrdlo • Dijamntska burgija • Διαμαντοτρύπανο • Broca de diamante • Punta al diamante • Broca de diamante • Foret diamanté

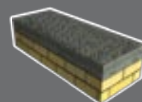
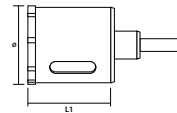

Ref.	Ø[mm]	L	EAN	
57H278	6	30	5902062572783	30/360
57H279	8	30	5902062572790	30/360
57H280	10	30	5902062572806	30/360
57H284	12	30	5902062572844	30/360
57H285	18	30	5902062572851	20/240
57H286	22	30	5902062572868	10/80
57H287	25	30	5902062572875	10/80
57H288	32	30	5902062572882	10/80
57H289	35	30	5902062572899	10/80
57H290	38	30	5902062572905	10/80
57H291	40	30	5902062572912	10/80
57H292	44	30	5902062572929	10/80
57H293	50	30	5902062572936	10/80
57H294	53	30	5902062572943	10/80
57H295	60	30	5902062572950	10/80
57H296	65	30	5902062572967	10/80
57H297	67	30	5902062572974	10/80
57H298	73	30	5902062572981	10/80
57H299	83	30	5902062572998	6/48
57H300	100	30	5902062573001	6/48

GRAPHITE

Adapter do wiertel diamentowych

Hole cutter adaptor • Adapter für betonstichsägen • Переходник для коронок по бетону • Adapter do wykrujalnika po betonu • Adapter fűrókalapáshoz • Adaptor sfredelirea sondelo • Adapter do dérovek na beton • Súprava vrtákov • Adapter za diamentne svedre • Adapteris karūnai, betonui gręžti • Adapters kronurbim • Augulõikuri adapter • Adapter za diamentni svredla • Adapter za dijamantna svrdla • Adapter za dijamantske burgije • Αντάπτορας για ποτρηκόρινα για μπετόν • Adaptador para brocas de diamante • Adattatore per seghe da traforo per calcestruzzo • Adaptador p. serras para recorte p. betão • Adaptateur de scie à guichet pour béton

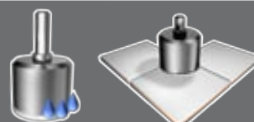
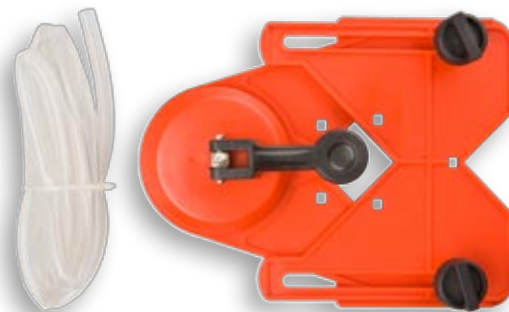

Ref.	info	EAN	
57H301	6-100mm	5902062573018	15/30

Wiertła do betonu

Concrete drills - Betonbohrer - Сверла по бетону - Сверла по бетону - Betonfúró - Burghie pentru beton - Vrtáky do betonu - Vrtáky do betonu - Svedri za beton - Gražtal betonul - Betona urbji - Betooinpuur - Сределна за бетон - Svrdlo za beton - Burğije za beton - Τρυπάνια μπετόν - Brocas para hormigón - Punte per calcestruzzo - Brocas p. Betão - Forêts pour béton

Ref.	Ø[mm]	L1	L2	EAN	
57H400	4	110	50	5902062574008	1/300
57H404	5	160	100	5902062574046	1/200
57H406	6	110	50	5902062574060	1/300
57H408	6	160	100	5902062574084	1/300
57H410	6	210	150	5902062574107	1/300
57H412	6	260	200	5902062574121	1/200
57H414	8	110	50	5902062574145	1/200
57H416	8	160	100	5902062574169	1/300
57H418	8	210	150	5902062574183	1/200
57H420	8	260	200	5902062574206	1/200
57H424	10	160	100	5902062574244	1/200
57H428	10	260	200	5902062574282	1/200
57H430	10	350	290	5902062574305	1/150
57H432	10	400	340	5902062574329	1/120
57H434	10	600	540	5902062574343	1/100
57H438	12	160	100	5902062574381	1/200
57H440	12	210	150	5902062574404	1/200
57H442	12	260	200	5902062574428	1/200
57H444	12	310	250	5902062574442	1/140
57H446	12	400	340	5902062574466	1/100
57H448	12	450	390	5902062574480	1/100
57H450	12	600	540	5902062574503	1/60
57H454	14	210	150	5902062574541	1/180
57H456	14	260	200	5902062574565	1/100
57H458	14	310	250	5902062574589	1/100
57H460	14	350	290	5902062574602	1/90
57H462	14	400	340	5902062574626	1/80
57H464	14	450	390	5902062574640	1/60
57H466	14	600	540	5902062574664	1/50
57H472	16	260	200	5902062574725	1/110
57H474	16	310	250	5902062574749	1/90
57H476	16	400	340	5902062574763	1/60
57H478	16	600	540	5902062574787	1/50
57H480	18	260	200	5902062574800	1/80
57H482	18	310	250	5902062574824	1/50
57H484	18	400	340	5902062574848	1/60
57H486	18	600	540	5902062574862	1/30
57H488	20	600	540	5902062574886	1/26
57H490	20	800	740	5902062574909	1/20
57H492	24	600	540	5902062574923	1/20
57H494	24	800	740	5902062574947	1/13

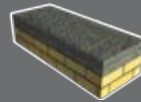
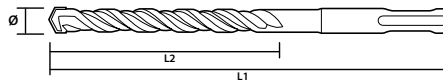

for **SDS^{MAX}**



GRAPHITE

Wiertła do betonu

Concrete drills - Betonbohrer - Сверла по бетону - Сверла по бетону - Betonfúró - Burghie pentru beton - Vrtáky do betonu - Vrtáky do betonu - Svedri za beton - Gražtal betonul - Betona urbji - Betooinpuur - Сределна за бетон - Svrdlo za beton - Burğije za beton - Τρυπάνια μπετόν - Brocas para hormigón - Punte per calcestruzzo - Brocas p. Betão - Forêts pour béton

Ref.	Ø[mm]	L1	L2	EAN	
57H504	16	260	120	5902062575043	1/42
57H506	16	310	170	5902062575067	1/43
57H508	16	400	260	5902062575081	1/37
57H510	16	600	460	5902062575104	1/30
57H512	18	260	120	5902062575128	1/59
57H514	18	310	170	5902062575142	1/50
57H516	18	400	260	5902062575166	1/45
57H518	18	600	460	5902062575180	1/30
57H520	20	600	460	5902062575203	1/22
57H522	20	800	660	5902062575227	1/16
57H524	24	600	460	5902062575241	1/17
57H526	24	800	660	5902062575265	1/12
57H528	24	1000	860	5902062575289	1/10
57H530	24	1200	1060	5902062575302	1/7
57H532	28	600	460	5902062575326	1/13
57H534	28	800	660	5902062575340	1/10
57H536	28	1000	860	5902062575364	1/7
57H538	28	1200	1060	5902062575388	1/6
57H540	32	600	460	5902062575401	1/10
57H542	32	800	660	5902062575425	1/6
57H544	32	1000	860	5902062575449	1/6
57H546	32	1200	1060	5902062575463	1/5

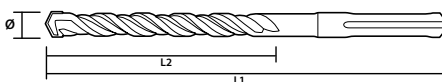

for **SDS^{MAX}**

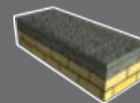

GRAPHITE

Diuto

Wood chisel - Beitel - Стамеска - Стамеска - Favésó - Daltálemn - Diáto - Diátóploché - Diéto - Kaltas - Kalts - Peitel - Длето - Dlijeto - Diéto - Σμιδη με ξυλινη λαβή - Formón - Scalpello - Raspador - Ciseau

Ref.	Ø[mm]	L	W	info	type	EAN	
57H556	14	250	-	SDS PLUS		5902062575562	15/60
57H557	14	250	20	SDS PLUS		5902062575579	15/60
57H558	14	250	40	SDS PLUS		5902062575586	15/60
57H559	17	350	50	SDS PLUS		5902062575593	15/30
57H560	14	250	22	SDS PLUS	U	5902062575609	15/60
57H561	18	400	-	SDS Max		5902062575616	13/26
57H562	18	400	25	SDS Max		5902062575623	13/26
57H563	18	400	50	SDS Max		5902062575630	13/26
57H564	18	350	25	SDS Max	U	5902062575647	13/26

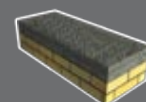
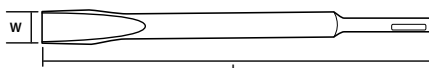

GRAPHITE

Point chisel • Spitzzeisen • Долото-пила • Пробивач • Hegyveséső • Daltā • Špičák • Sekáč
 špicaty SDSplus • Κοιλιέσφι σακάκ • Pincetas • Kalts špicais • Terava otsaga peitel • Шило
 SDS Plus 14 • Śpica • Spic • Σμίλη αχμηρού άκρου • Cincel • Punteruolo • Cincel • Poînçon

Szpicak

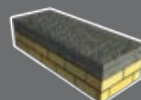
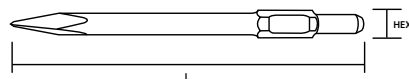

Ref.	hex [mm]	L [mm]	m [kg]	EAN	
57H565	30	400	1,5	5902062575654	0/15

GRAPHITE

Wood chisel • Beitel • Стамеска • Стамеска • Favéső • Daltāleimn • Dlátō • Dlátō ploché • Dleto • Kaltas
 • Kalts • Peitel • Длето • Dlijeto • Dleto • Σμίλη με ξόδινη λαβή • Formón • Scalpello • Raspador • Ciseau

Dłuto

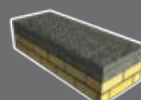
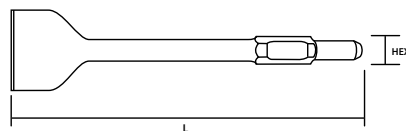

Ref.	hex [mm]	L [mm]	W [mm]	m [kg]	EAN	
57H566	30	400	35	1,5	5902062575661	0/15
57H567	30	400	75	2,4	5902062575678	0/10

GRAPHITE

Stepped Conical Bit • Stufenbohrer • Сверло ступенчатое • Сверло ступеневе • Lépcsős fúró • Burghiu lărgitor conic • Stupnovity vrták • Stupnovity vrták • Stopenjski sveder • Pakorinis grąžtas • Pakarjveida urbis • Astmeline puur • Многоступенно сверло • Stopenasto svrdlo • Konusna - stepenasta burgrja • Τρυπάνι διάνοιξης σπών με διαβάθμιση • Broca con grados • Allargatori a gradino • Broca de graus • Foret étage

Wiertło stopniowe



Ref.	Ø[mm]	EAN	
57H739	4 - 22	5902062577399	1/150
57H740	4 - 32	5902062577405	1/50

HSS

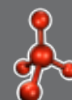
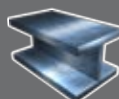

Wiertło bezstopniowe

Stepless Conical Bit - Stufenloser Bohrer - Сверло коническое - Сверло коничное - Kúrosfúró - Burghiu nelárgitor - Kuželový vrták - Kuželový vrták - Stožčasti sveder - Konusinis grąžtas - Koniskais urbis - Koopusspuur - Конично сверло - Konusno svrdlo - Glatka burgija - Τριπλάμι με κωνικό στέλεχος - Broca sin gradus - Allargafori - Broca sem graus - Foret non étage

Ref.	Ø[mm]	EAN	
57H741	4-32	5902062577412	1/50



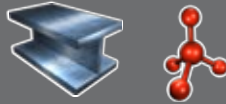

HSS



GRAPHITE

Frezy

Milling cutters - Fräser - Фрезы - Фрези - Marókések - Freze - Frézy - Frézy - Rezkala - Frezos - Frézes - Freesid - Фрези - Frezeri - Glodalice, freziri - Φρέζες - Brocas fresadoras - Frese - Fresas - Fraises

Ref.	NR	Ø1 [mm]	Ø2 [mm]		R	H		EAN	
57H210	1	8	6			20	12	5902062572103	5/20
		8	12			20			
		8	16			20			
		8	12.7			12			
	5	8	12.7	90		9			
	6	8	32	45		12			
	7	8	12.7			12			
	8	8	22.2		6	12			
	9	8	28.6		9.5	15			
	10	8	12.7		6.35	9			
	11	8	22.2		6	12			
	12	8	25.4		4	15			

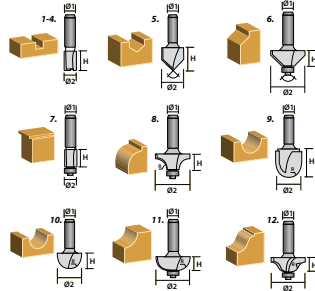

TCT

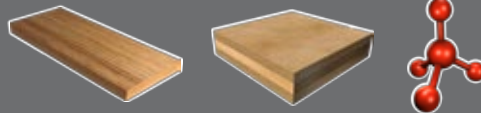

GRAPHITE

Wiertło do drewna

Auger Bit - Holzbohrer - Сверло по дереву винтовое - Сверло червячне - Gerendafúró - Burghiu pentru lemn - Spirálový vrták do dřeva - Spirálový vrták do dřeva - Sveder za les - Spiralinis medžio grąžtas - Skrünveida urbis koksnei - Puidupuur - Середло за дърво - Svrdlo za drvo - Burgija za drvo - Σπειροειδές τριπλάμι ξύλου - Broca para madeira - Punta a elica - Broca para madeira - Foret à bois

Ref.	Ø[mm]	L1	L2	EAN	
57H270	3	60	30	5902062572707	50/400
57H271	4	70	40	5902062572714	50/400
57H272	5	85	45	5902062572721	50/400
57H273	6	90	50	5902062572738	50/400
57H274	7	105	60	5902062572745	50/400
57H275	8	110	65	5902062572752	50/400
57H276	10	120	75	5902062572769	50/400

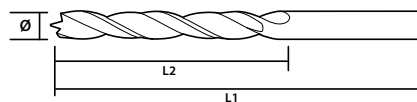

GRAPHITE

Wiertło do drewna

Auger Bit • Holzbohrer • Сверло по дереву винтовое • Сверло черв'ячне • Gerendafúró • Burghiu pentru lemn • Spirálový vrták do dřeva • Spirálový vrták do dřeva • Sveder za les • Spiralinis medžio grąžtas • Skrūvveida urbis koksnei • Puidupuur • Средло за дърво • Svrdlo za drvo • Burgija za drvo • Σπειροειδές τρυπάνι ξύλου • Broca para madeira • Punta a elic • Broca para madeira • Foret à bois

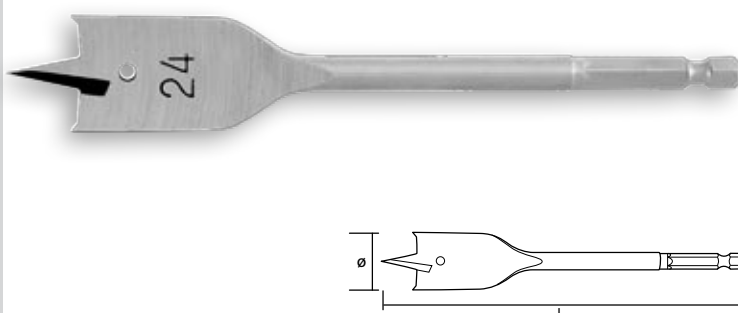

Ref.	Ø[mm]	L	EAN	
57H212	6	152	5902062572127	40/400
57H214	8	152	5902062572141	40/400
57H216	10	152	5902062572165	40/400
57H218	12	152	5902062572189	40/400
57H220	14	152	5902062572202	40/400
57H222	16	152	5902062572226	40/400
57H224	18	152	5902062572240	40/400
57H226	20	152	5902062572264	40/400
57H228	22	152	5902062572288	40/400
57H230	24	152	5902062572301	40/400
57H232	26	152	5902062572325	40/400
57H234	28	152	5902062572349	40/400
57H236	30	152	5902062572363	40/400
57H238	32	152	5902062572387	40/400
57H240	34	152	5902062572400	40/400
57H242	38	152	5902062572424	40/320
57H244	40	152	5902062572448	40/320

GRAPHITE

Przedłużka do wiertel

Extension • Verlängerung • Удлинитель • Подожувач • Toldósár • Prolungtor • Prodlužovák • Predženie • Podaljšek • Ilgiklis • Pagarinātājs • Piekendus • Удължител • Produženi poluga • Produzena poluga • Προέκταση • Alargadera • Prolunga • Extensão • Prolongation

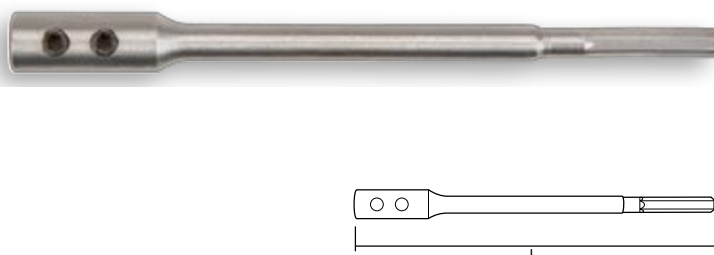

Ref.	L[mm]	EAN	
57H245	150	5902062572455	20/200

GRAPHITE

Wiertło do drewna

Auger Bit • Holzbohrer • Сверло по дереву винтовое • Сверло черв'ячне • Gerendafúró • Burghiu pentru lemn • Spirálový vrták do dřeva • Spirálový vrták do dřeva • Sveder za les • Spiralinis medžio grąžtas • Skrūvveida urbis koksnei • Puidupuur • Средло за дърво • Svrdlo za drvo • Burgija za drvo • Σπειροειδές τρυπάνι ξύλου • Broca para madeira • Punta a elic • Broca para madeira • Foret à bois

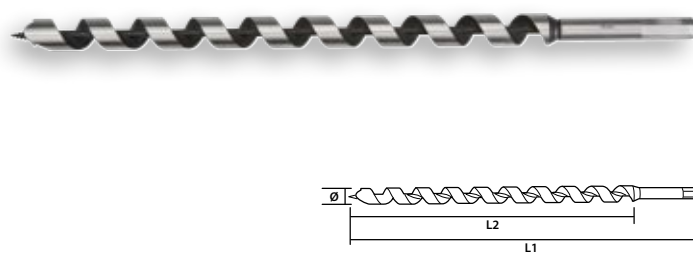



Ref.	Ø[mm]	L1	L2	EAN	
57H352	6	250	150	5902062573520	25/50
57H354	8	250	150	5902062573544	25/50
57H356	10	250	150	5902062573568	25/50
57H358	12	250	150	5902062573582	25/50
57H360	14	250	150	5902062573605	25/50
57H362	16	250	150	5902062573629	25/50
57H364	18	250	150	5902062573643	25/50
57H366	20	250	150	5902062573667	25/50
57H368	22	250	150	5902062573681	25/50
57H370	24	250	150	5902062573704	25/50
57H372	25	250	150	5902062573728	25/50
57H252	8	400	300	5902062572523	25/50
57H253	10	400	300	5902062572530	25/50
57H254	12	400	300	5902062572547	25/50
57H255	14	400	300	5902062572554	25/50
57H256	16	400	300	5902062572561	25/50
57H257	18	400	300	5902062572578	25/50
57H258	20	400	300	5902062572585	25/50



Otwornica

Compass saw • Lochsäge • Ножовка • Фреза • Körkivágó • Ferástráu pentru găuri • Dėrovka • Dierovacica pila • Luknjariča • Vianarankis pjūklas • Rokzāģis • Augusaag • Тесен трион • Nareznica • Ručna testera za pravljenje otvora • Прили • Sierra de corona • Segă a tază • Serra para recorte • Scie à guichet

Ref.	Ø[mm]	H		EAN	
57H957	28-75	30	5	5902062579577	6/30

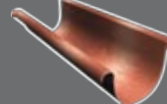
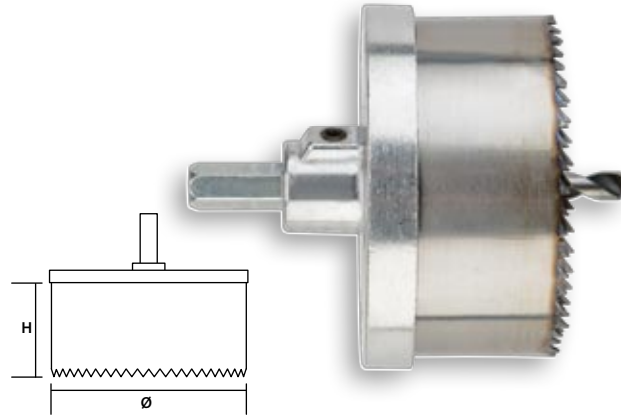

GRAPHITE

Frezy

Milling cutters • Fräser • Фрезы • Фрези • Marókések • Freze • Frézy • Frézy • Rezkala • Frezos • Frézes • Freesid • Фрези • Frezeri • Glodalice, frezeri • Φρέζες • Brocas fresadoras • Frese • Fresas • Fraises

Ref.	Ø[mm]	L[mm]	EAN	
57H266	25	60	5902062572660	1/100
57H267	32	60	5902062572677	1/100
57H268	35	60	5902062572684	1/90

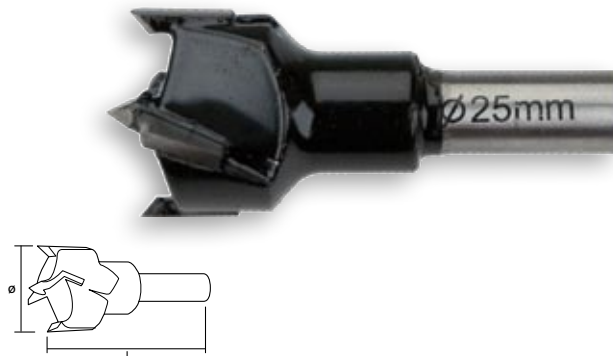

TCT

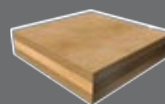

GRAPHITE

Frezy

Milling cutters • Fräser • Фрезы • Фрези • Marókések • Freze • Frézy • Frézy • Rezkala • Frezos • Frézes • Freesid • Фрези • Frezeri • Glodalice, frezeri • Φρέζες • Brocas fresadoras • Frese • Fresas • Fraises

Ref.	Ø[mm]		L	EAN	
57H246	15, 18, 20, 22	4	130	5902062572462	12/48

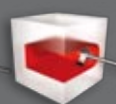
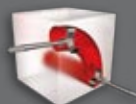

**HSS
TiN**

GRAPHITE

Wiertła do drewna

Auger Bit • Holzbohrer • Сверло по дереву винтовое • Сверло червячне • Gerendafúró • Burghiu pentru lemn • Spirálový vrták do dřeva • Spirálový vrták do dreva • Sveder za les • Spirális medzlo gražtas • Skruvveida urbis koksnei • Puidupuur • Сверло за дърво • Svrdlo za drvo • Burgija za drvo • Σπειροειδής τρυπάνι ξύλου • Broca para madeira • Punta a elica • Broca para madeira • Foret à bois

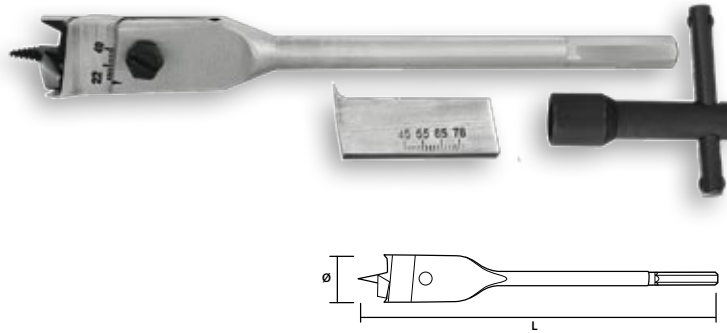

Ref.	Ø[mm]	L	EAN	
57H248	22-76	150	5902062572486	20/40



GRAPHITE

Wiertła-pily

Saw drills • Bohrer • Säge • Сверла-пилы • Сверла-фрезы • Marófúró • Burghie - ferăstrău • Vrtáky / Pily • Frézovací vrták • Svedri-žage • Gražtai - pjūklai • Urbji-zāgi • Puurid-saed • Сверла-триони • Svrdla pile • Burgije-testere • Пришворта трепанца • Brocas sierras • Punte-seghe • Forêts-scies

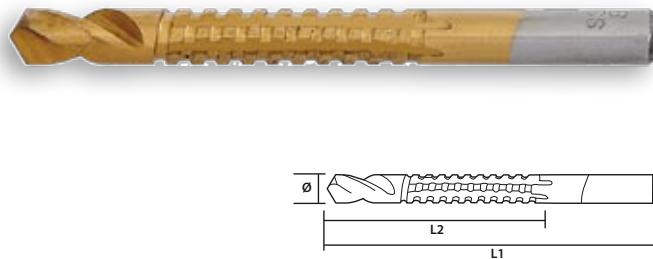

Ref.	Ø[mm]	EAN	
57H250	5,6,8	5902062572509	12/60

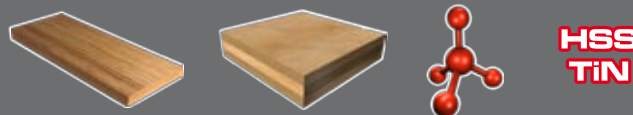

GRAPHITE

Wiertła do betonu

Concretedrills • Betonbohrer • Сверла по бетону • Сверла по бетону • Betonfúró • Burghie pentru beton • Vrtáky do betonu • Vrtáky do betonu • Svedri za beton • Gražtai betonui • Betona urbj • Betoopirruur • Сверла за бетон • Svrdlo za beton • Burgije za beton • Τρυπανια μπετόν • Brocas para hormigón • Punte per calcestruzzo • Brocas p. Betão • Forêts pour béton

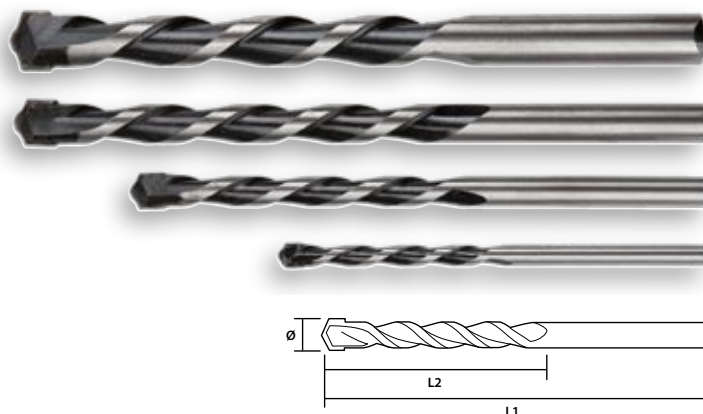

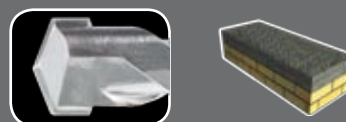

Ref.	Ø[mm]	L1	L2		EAN	
57H746	4	75	40	4	5902062577467	30/120
	6	100	60			
	8	120	80			
	10	120	80			



Wiertła do metalu

Metal drills • Metallbohrer • Сверла по металлу • Сверла по металу • Fémfúró • Burghis pentru metale • Vrtáky do kovu • Vrtáky do kovno • Svedri za kovino • Gražtal metalui • Urbis metšlam • Metallpiir • Сврла за метал • Svredla za metal • Burgija za metal • Τρυπάνια μετάλλου • Brocas para metal • Punte per metallo • Brocas p. metal • Forêts à métal

Ref.	Ø[mm]	L1	L2		EAN	
57H750	4	95	40	5	5902062577504	30/120
	5	105	50			
	6	112	55			
	8	115	70			
	10	132	85			

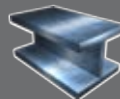
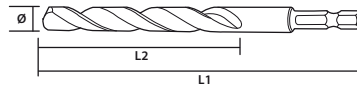



GRAPHITE



Olej

Oil • Öl • Масло • Олива • Motorolaj • Ulei • Olej • Olejovač • Olje • Alyva • Eļļa • Óil • Масло • Ulje • Ulje • Λάδι • Aceite • Olio • Óleo • Huile



Ref.		EAN	
57H742	1l	5902062577429	1/10



GRAPHITE

Olej

Oil • Öl • Масло • Олива • Motorolaj • Ulei • Olej • Olejovač • Olje • Alyva • Eļļa • Óil • Масло • Ulje • Ulje • Λάδι • Aceite • Olio • Óleo • Huile

Ref.		EAN	
57H743	1l	5902062577436	1/10



GRAPHITE

GRAPHITE

Olej

Oil • Öl • Масло • Oliwa • Motorolaj • Ulei • Olej • Olejovač • Olja • Alyva • Eija • Ölj • Macno • Ulje • Ulje • Adži • Aceite • Olio • Óleo • Huile





Ref.		EAN	
57H744	50ml	5902062577443	1/100

GRAPHITE

Smar

Grease • Schmierstoff • Смазочное масло • Мазило • Kenőzsír • Unsoare consistentă • Mazivo • Mazivo • Mazivo • Terpas • Směřelja • Määre • Смазка • Nazivo • Mazivo • Грџо • Engrase • Grasso • Lubrificante • Graisse



Ref.		EAN	
57H745	50ml	5902062577450	1/100

GRAPHITE

Tarczce diamentowe

Diamond discs • Diamantschleifscheibe • Алмазные круги • Диск діамантовий • Gyémánt csiszolókorong • Discuri diamantate • Diamantové kotouče • Diamantové kotouče • Diamantne plošče • Deimantiniai diskai • Dimantu diskai • Teemantkettad • Диамантени дискове • Dijamantne ploče • Ploče za dijamante • Διαμαντοτροχός • Disco de diamante • Dischi diamantati • Discos de diamante • Disques diamantés



Ref.	Ø1 [mm]	Ø2 [mm]	H [mm]	W [mm]	EAN	
57H865	115	22	8.0	2.2	5902062578655	50/100
57H866	125	22	8.0	2.4	5902062578662	50/100
57H868	230	22	8.0	2.5	5902062578686	1/25

DIAMOND CUT



LASER WELDED

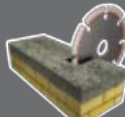

MPA EN13236

Tarce diamentowe

Diamond discs • Diamantschleifscheibe • Алмазные круги • Диск діамантовий • Gyémánt csiszolókorong • Discuri diamantate • Diamantové kotouče • Diamantové kotúče • Diamantne plošče • Deimantiniiai diskai • Dimantu diskai • Teemantkettad • Диамантени дискове • Dijamantne ploče • Ploče za dijamante • Διαμαντοτροχός • Disco de diamante • Dischi diamantati • Discos de diamante • Disques diamantés

Ref.	Ø1 [mm]	Ø2 [mm]	H [mm]	W [mm]	EAN	
57H604	115	22	8.0	2.2	5902062576040	10/100
57H606	125	22	8.0	2.2	5902062576064	10/100
57H608	180	22	8.0	2.4	5902062576088	10/50
57H869	200	25.4	8.0	2.4	5902062578693	0/50
57H610	230	22	8.0	2.5	5902062576101	10/30

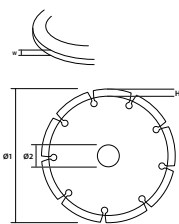

DIAMOND CUT



LASER WELDED

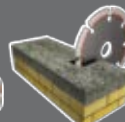

MPA EN13236

Tarce diamentowe

Diamond discs • Diamantschleifscheibe • Алмазные круги • Диск діамантовий • Gyémánt csiszolókorong • Discuri diamantate • Diamantové kotouče • Diamantové kotúče • Diamantne plošče • Deimantiniiai diskai • Dimantu diskai • Teemantkettad • Диамантени дискове • Dijamantne ploče • Ploče za dijamante • Διαμαντοτροχός • Disco de diamante • Dischi diamantati • Discos de diamante • Disques diamantés

Ref.	Ø1 [mm]	Ø2 [mm]	H [mm]	W [mm]	EAN	
57H612	300	25.4	10.0	3.2	5902062576125	1/10
57H614	350	25.4	10.0	3.2	5902062576149	1/10

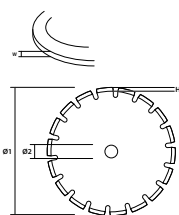

DIAMOND CUT



LASER WELDED



MPA EN13236

ASPHALT

Tarce diamentowe

Diamond discs • Diamantschleifscheibe • Алмазные круги • Диск діамантовий • Gyémánt csiszolókorong • Discuri diamantate • Diamantové kotouče • Diamantové kotúče • Diamantne plošče • Deimantiniiai diskai • Dimantu diskai • Teemantkettad • Диамантени дискове • Dijamantne ploče • Ploče za dijamante • Διαμαντοτροχός • Disco de diamante • Dischi diamantati • Discos de diamante • Disques diamantés

Ref.	Ø1 [mm]	Ø2 [mm]	H [mm]	W [mm]	EAN	
57H616	115	22	8.0	2.1	5902062576163	10/100
57H617	125	22	8.0	2.2	5902062576170	10/100
57H618	180	22	8.0	2.5	5902062576187	10/100
57H870	200	25.4	8.0	2.5	5902062578709	0/50
57H619	230	22	8.0	2.7	5902062576194	10/100

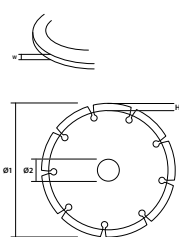

DIAMOND CUT



LASER WELDED



MPA EN13236

ASPHALT

GRAPHITE

Tarce diamentowe

Diamond discs • Diamantschleifscheibe • Алмазные круги • Диск діамантовий • Gyémánt csiszolókorong • Discuri diamantate • Diamantové kotouče • Diamantové kotúče • Diamantne plošče • Deimantiniai diskai • Dimantu diskai • Teemantkettad • Диамантени дискове • Dijamantne ploče • Ploče za dijamente • Διαμαντοτροχός • Disco de diamante • Dischi diamantati • Discos de diamante • Disques diamants

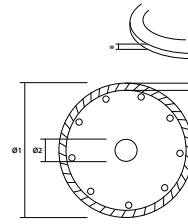

Ref.	Ø1 [mm]	Ø2 [mm]	H [mm]	W [mm]	EAN	Box
57H620	115	22.2	6.0	1.3	5902062576200	10/50
57H621	125	22.2	6.0	1.4	5902062576217	10/50
57H622	180	22.2	6.0	1.6	5902062576224	10/30
57H872	200	25.4	6.0	1.6	5902062578723	0/50
57H623	230	22.2	6.0	1.8	5902062576231	10/30

GRAPHITE

Tarce diamentowe

Diamond discs • Diamantschleifscheibe • Алмазные круги • Диск діамантовий • Gyémánt csiszolókorong • Discuri diamantate • Diamantové kotouče • Diamantové kotúče • Diamantne plošče • Deimantiniai diskai • Dimantu diskai • Teemantkettad • Диамантени дискове • Dijamantne ploče • Ploče za dijamente • Διαμαντοτροχός • Disco de diamante • Dischi diamantati • Discos de diamante • Disques diamants

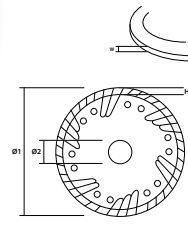

Ref.	Ø1 [mm]	Ø2 [mm]	H [mm]	W [mm]	EAN	Box
57H625	115	22.2	6.0	2.4	5902062576255	10/50
57H626	125	22.2	6.0	2.6	5902062576262	10/50
57H628	180	22.2	6.0	2.8	5902062576286	10/30
57H871	200	25.4	6.0	2.8	5902062578716	0/50
57H630	230	22.2	6.0	3.1	5902062576309	10/30

GRAPHITE

Tarce diamentowe

Diamond discs • Diamantschleifscheibe • Алмазные круги • Диск діамантовий • Gyémánt csiszolókorong • Discuri diamantate • Diamantové kotouče • Diamantové kotúče • Diamantne plošče • Deimantiniai diskai • Dimantu diskai • Teemantkettad • Диамантени дискове • Dijamantne ploče • Ploče za dijamente • Διαμαντοτροχός • Disco de diamante • Dischi diamantati • Discos de diamante • Disques diamants

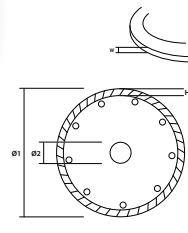

Ref.	Ø1 [mm]	Ø2 [mm]	H [mm]	W [mm]	EAN	Box
57H632	115	22.2	6.0	2.4	5902062576323	10/50
57H634	125	22.2	6.0	2.6	5902062576347	10/50
57H636	180	22.2	6.0	2.8	5902062576361	10/30
57H873	200	25.4	6.0	2.8	5902062578730	0/50
57H638	230	22.2	6.0	3.1	5902062576385	10/30

Tarczce diamentowe

Diamond discs • Diamantschleifscheibe • Алмазные круги • Диск діамантовий • Gyémánt csiszolókorong • Discuri diamantate • Diamantové kotouče • Diamantové kotúče • Diamantne plošče • Deimantiniiai diskai • Dimantu diskai • Teemantkettad • Диамантени дискове • Dijamantne ploče • Ploče za dijamante • Διαμαντοτροχός • Disco de diamante • Dischi diamantati • Discos de diamante • Disques diamantés

GRAPHITE

Ref.	Ø1 [mm]	Ø2 [mm]	H [mm]	W [mm]	EAN	
57H640	115	22.2	6.0	2.1	5902062576408	10/100
57H642	125	22.2	6.0	2.2	5902062576422	10/100
57H644	180	22.2	6.0	2.5	5902062576446	10/50
57H874	200	25.4	6.0	2.5	5902062578747	0/50
57H646	230	22.2	6.0	2.7	5902062576460	10/30

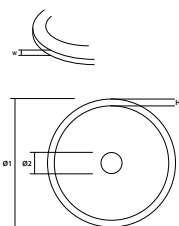

DIAMOND CUT

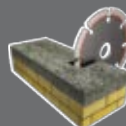

**MPA
EN13236**

Tarczce diamentowe

Diamond discs • Diamantschleifscheibe • Алмазные круги • Диск діамантовий • Gyémánt csiszolókorong • Discuri diamantate • Diamantové kotouče • Diamantové kotúče • Diamantne plošče • Deimantiniiai diskai • Dimantu diskai • Teemantkettad • Диамантени дискове • Dijamantne ploče • Ploče za dijamante • Διαμαντοτροχός • Disco de diamante • Dischi diamantati • Discos de diamante • Disques diamantés

GRAPHITE

Ref.	Ø1 [mm]	Ø2 [mm]	H [mm]	EAN	
57H883	115	22.2	5.0	5902062578839	1/10
57H884	125	22.2	5.0	5902062578846	1/10
57H885	180	22.2	5.0	5902062578853	1/5

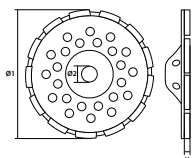

DIAMOND CUT

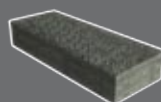

Tarczce diamentowe

Diamond discs • Diamantschleifscheibe • Алмазные круги • Диск діамантовий • Gyémánt csiszolókorong • Discuri diamantate • Diamantové kotouče • Diamantové kotúče • Diamantne plošče • Deimantiniiai diskai • Dimantu diskai • Teemantkettad • Диамантени дискове • Dijamantne ploče • Ploče za dijamante • Διαμαντοτροχός • Disco de diamante • Dischi diamantati • Discos de diamante • Disques diamantés

GRAPHITE

Ref.	Ø1 [mm]	Ø2 [mm]	H [mm]	EAN	
57H886	115	22.2	5.0	5902062578860	1/10
57H887	125	22.2	5.0	5902062578877	1/10
57H888	180	22.2	5.0	5902062578884	1/5

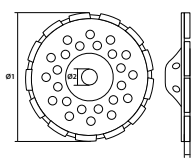

DIAMOND CUT

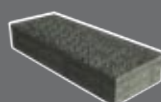

GRAPHITE

Tarcze diamentowe

Diamond discs • Diamantschleifscheibe • Алмазные круги • Диск діамантовий • Gyémánt csiszolókorong • Discuri diamantate • Diamantové kotouče • Diamantové kotúče • Diamantne plošče • Deimantiniai diskai • Dimantu diskai • Teemantkettad • Диамантени дискове • Dijamantne ploče • Ploče za dijamente • Διαμαντογκόφες • Disco de diamante • Dischi diamantati • Discos de diamante • Disques diamantés

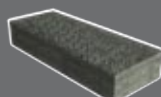
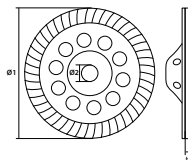

Ref.	Ø1 [mm]	Ø2 [mm]	H [mm]	EAN	
57H889	115	22.2	5.0	5902062578891	1/10
57H890	125	22.2	5.0	5902062578907	1/10
57H891	180	22.2	5.0	5902062578914	1/5

GRAPHITE

Otwornica

Compass saw • Lochsäge • Нововка • Фреза • Körkivágó • Ferăstrău pentru găuri • Dėrovka • Dėrovacia pila • Luknarica • Vienarankis pjūklas • Rokzāģis • Augusaag • Тесен трион • Nareznica • Ručna testera za pravljenje otvora • Πριόβι • Sierra de corona • Sega a tazza • Serra para recorte • Scie à guichet

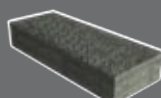
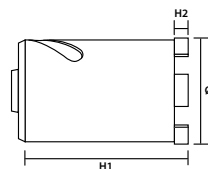

Ref.	Ø [mm]	H1 [mm]	H2 [mm]	EAN	
57H875	62	75	8	5902062578754	1/5
57H876	68	75	8	5902062578761	1/5
57H877	72	75	8	5902062578778	1/5
57H878	82	75	8	5902062578785	1/5

GRAPHITE

Aksesoria do otwornic

Accessories for hole cutters • Zubehör für Lochsägen • Принадлежности для корончатых сверл • Приналежності до фрез • Körkivágó tartozékok • Accesorii de ferăstrău pentru orificii • Prislusēnstvi pro dėrovky • Prislusēnstvo k dėrovacim pilam • Pribor za luknarice • Priedai vienarankiam pjūklui • Liela diametra urbju aksesuāri • Kroonpuuride tarvikud • Аксесорји за тесни триони • Pribor za bušanje rupa • Pribor za testeru za pravljenje otvora • Εξαρτήματα για κοπτήρες • Accesorios para sierras de corona





	Ref.	EAN	
1	57H879	5902062578792	1/50
2	57H880	5902062578808	1/50
3	57H881	5902062578815	1/50

Tarcze do pilarki

Circular saw blade - Sägeblatt - Диск пильный - Диск пильный по металлу циркулярной - Körfűrészlap - Lamă circulară p/ă ferăstrău - Pilový kotouč - Pilový kotouč - List za krožno žago - Plovnimo diskas pjūklui - Zągła igrá - Kreissägeketas - Диск за циркуляр - Kružna Pila - List kruczne testere - Δίσκος κοπής - Δίσκος κοπής - Disco de corte para sierra circular - Disco per segatrice - Disco p. disco de limar - Disque à scie rotative

GRAPHITE



Ref.	Ø1 [mm]	Ø2 [mm]		W1 [mm]	W2 [mm]	info		EAN	
57H656	160	30	18	2.0	2.8		30x20 ; 30x25.4 ; 30x16	5902062576569	50/100
57H658	160	30	24	2.0	2.8		30x20 ; 30x25.4 ; 30x16	5902062576583	50/100
57H660	160	30	30	2.0	2.8		30x20 ; 30x25.4 ; 30x16	5902062576606	50/100
57H648	165	30	18	2.0	2.8		30x20 ; 30x25.4 ; 30x16	5902062576484	50/100
57H650	165	30	24	2.0	2.8		30x20 ; 30x25.4 ; 30x16	5902062576507	50/100
57H652	165	30	30	2.0	2.8		30x20 ; 30x25.4 ; 30x16	5902062576521	50/100
57H654	165	30	30	2.2	3.2	aluminium	30x20 ; 30x25.4 ; 30x16	5902062576545	50/100
57H662	185	30	24	2.2	3.2		30x20 ; 30x25.4 ; 30x16	5902062576620	25/50
57H664	185	30	36	2.2	3.2		30x20 ; 30x25.4 ; 30x16	5902062576644	25/50
57H666	185	30	48	2.2	3.2		30x20 ; 30x25.4 ; 30x16	5902062576668	25/50
57H668	190	30	24	2.2	3.2		30x20 ; 30x25.4 ; 30x16	5902062576682	25/50
57H670	190	30	40	2.2	3.2		30x20 ; 30x25.4 ; 30x16	5902062576705	25/50
57H672	190	30	50	2.2	3.2		30x20 ; 30x25.4 ; 30x16	5902062576729	25/50
57H674	200	30	24	2.2	3.2		30x20 ; 30x25.4 ; 30x16	5902062576743	25/50
57H676	200	30	40	2.2	3.2		30x20 ; 30x25.4 ; 30x16	5902062576767	25/50
57H678	200	30	60	2.2	3.2		30x20 ; 30x25.4 ; 30x16	5902062576781	25/50
57H682	205	30	36	2.2	3.2		30x20 ; 30x25.4 ; 30x16	5902062576828	25/50
57H679	216	30	36	2.2	3.2		30x20 ; 30x25.4 ; 30x16	5902062576798	1/50
57H680	216	30	48	2.2	3.2		30x20 ; 30x25.4 ; 30x16	5902062576804	1/50
57H681	216	30	60	2.2	3.2		30x20 ; 30x25.4 ; 30x16	5902062576811	1/50
57H684	250	30	40	2.2	3.2		30x20 ; 30x25.4 ; 30x16	5902062576842	1/25
57H686	255	30	40	2.2	3.2		30x20 ; 30x25.4 ; 30x16	5902062576866	1/25

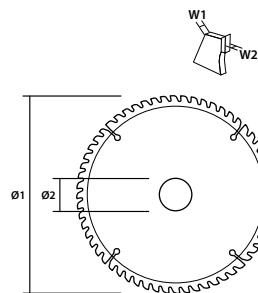

TCT



Tarcze tnące

Cutting discs - Schneidscheibe - Режущие диски - Диски пильни - Vágótárcsák - Discuri tăietoare - Rezací kotouče - Rezné kotúče - Rezinne plošče - Plovnimo diskai - Zągdzisk - Lökkekettad - Режущи дискове - Rezne ploče - Ploče zasečenje - Δίσκοι κοπής - Discos de corte - Molada taglio - Discos cortantes - Disques de coupage

GRAPHITE

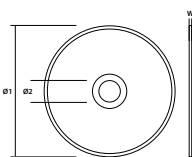

Ref.	Ø1 [mm]	Ø2 [mm]	W	info	EAN	
57H690	125	22	0.8	57A60Z-BF07 FREE OFF FE+S+CL	5902062578860	1/25
57H730	115	22	1.0	41 A60-T-BF INOX (Fe+S+Cl<0,1%)	5902062578877	1/25
57H733	125	22	1.0	41 A60-T-BF INOX (Fe+S+Cl<0,1%)	5902062578884	1/25

OS
10258

Fe+S+Cl



INOX

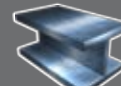

GRAPHITE

Tarce tnące

Cutting discs • Schneidscheibe • Режущие диски • Диски пильные • Vágótárcsák • Discuri tăietoare • Rezací kotouče • Rezné kotúče • Rezinne plošče • Pjovimo diskai • Zágðisks • Löikekettad • Режущи дискове • Rezne ploče • Ploče za sečenje • Δίσκοι κοπή • Discos de corte • Mola da taglio • Discos cortantes • Disques de coupage

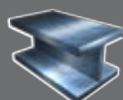
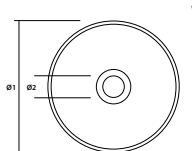

Ref.	Ø1 [mm]	Ø2 [mm]	W		EAN	
57H700	125	22	1.6	41 A60-T-BF	5902062577009	1/25
57H705	115	22	1.0	41 A60-T-BF	5902062577054	1/25
57H706	115	22	2.5	41 A30-T-BF	5902062577061	1/25
57H707	125	22	1.0	41 A60-T-BF	5902062577078	1/25
57H708	125	22	2.5	41 A30-T-BF	5902062577085	1/25
57H718	180	22	1.6	41 A46-S-BF	5902062577184	1/25
57H719	230	22	1.9	41 A46-S-BF	5902062577191	1/25
57H711	300	32	3.0	41 A24-T-BF	5902062577115	1/10
57H712	350	32	3.5	41 A24-T-BF	5902062577122	1/10
57H738	355	25.4	3.0	41 A30-T-BF	5902062577382	1/10
57H713	400	32	4.0	41 A24-T-BF	5902062577139	1/10

GRAPHITE

Tarce szlifierskie

Grinding discs • Schleifscheiben • Шлифовальные круги • Круги шлифовальные / гоцильні • Kőszűrőkörök • Discuri de polizor • Brusné kotouče • Brusny kotúč • Brusne plošče • Slifavimo diskai • Šliferšanas diski • Lihvkettad • Шлифовні дискове • Brusne ploče • Ploče za brusjenje • Τροχοί λείανσης • Muela de vasos de diamante para amoladora • Mola abrasiva • Discos de esmerilhãr • Disques de meulage

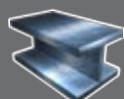
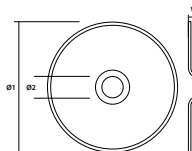

Ref.	Ø1 [mm]	Ø2 [mm]	W		EAN	
57H714	115	22	6.4	27 A30-S-BF	5902062577146	1/10
57H715	125	22	6.4	27 A30-S-BF	5902062577153	1/10
57H716	180	22	6.4	27 A24-S-BF	5902062577160	1/10
57H717	230	22	6.4	27 A24-S-BF	5902062577177	1/10

GRAPHITE

Tarce tnące

Cutting discs • Schneidscheibe • Режущие диски • Диски пильные • Vágótárcsák • Discuri tăietoare • Rezací kotouče • Rezné kotúče • Rezinne plošče • Pjovimo diskai • Zágðisks • Löikekettad • Режущи дискове • Rezne ploče • Ploče za sečenje • Δίσκοι κοπή • Discos de corte • Mola da taglio • Discos cortantes • Disques de coupage

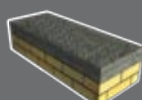
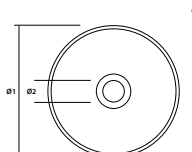

Ref.	Ø1 [mm]	Ø2 [mm]	W		EAN	
57H720	115	22	1.6	41 37C30-R-BF	5902062577146	1/25
57H722	125	22	1.6	41 37C30-R-BF	5902062577153	1/10
57H724	180	22	3.2	42 37C30-R-BF	5902062577160	1/10
57H725	230	22	3.2	42 37C30-R-BF	5902062577177	1/10

Szczotka druciana

Wirebrush - Drahtbürste - Щетка проволочная - Щітка по металу - Spidkefe - Perie metal - Drátěný kartáč - Kefa drótená univerzálna - Zična krtača - Vielinis šepetys - Dräsubürste - Traathari - Черка телена - Cetkasa PVC drskom - Cetka - Συρματίνη βούρτσα - Cepillo de alambre - Spazzola metallica - Escova de arame - Brosse métallique

Ref.	Ø[mm]	EAN	
57H581	65	5902062575814	6/60
57H582	80	5902062575821	6/60
57H583	100	5902062575838	6/30

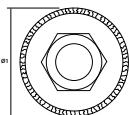

Szczotka druciana

Wirebrush - Drahtbürste - Щетка проволочная - Щітка по металу - Spidkefe - Perie metal - Drátěný kartáč - Kefa drótená univerzálna - Zična krtača - Vielinis šepetys - Dräsubürste - Traathari - Черка телена - Cetkasa PVC drskom - Cetka - Συρματίνη βούρτσα - Cepillo de alambre - Spazzola metallica - Escova de arame - Brosse métallique

Ref.	Ø[mm]	EAN	
57H585	80	5902062575852	6/60
57H587	100	5902062575876	6/30

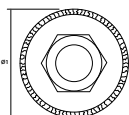

Szczotka druciana

Wirebrush - Drahtbürste - Щетка проволочная - Щітка по металу - Spidkefe - Perie metal - Drátěný kartáč - Kefa drótená univerzálna - Zična krtača - Vielinis šepetys - Dräsubürste - Traathari - Черка телена - Cetkasa PVC drskom - Cetka - Συρματίνη βούρτσα - Cepillo de alambre - Spazzola metallica - Escova de arame - Brosse métallique

Ref.	Ø[mm]	EAN	
57H589	100	5902062575890	6/60
57H591	115	5902062575913	6/60

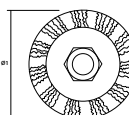

GRAPHITE

GRAPHITE

GRAPHITE

GRAPHITE

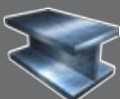
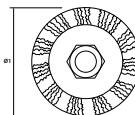

Szczotka druciana

Wirebrush • Drahtbürste • Щетка проволочная • Щетка по металлу • Spidkefe • Perie metal • Drátěný kartáč • Keďa drótená univerzálna • Zična krtača • Vielinis šepetys • Dräsu birste • Traathari • Четка телена • Cetka sa PVC držskom • Cetka • Συρμάτινη βούρτσα • Cepillo de alambre • Spazzola metallica • Escova de arame • Brosse métallique

Ref.	Ø[mm]	EAN	
57H596	115	5902062575968	6/60
57H598	125	5902062575982	6/60

GRAPHITE

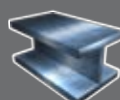
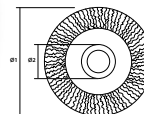
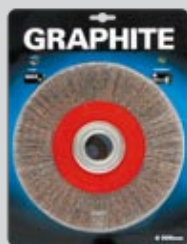

Szczotka druciana

Wirebrush • Drahtbürste • Щетка проволочная • Щетка по металлу • Spidkefe • Perie metal • Drátěný kartáč • Keďa drótená univerzálna • Zična krtača • Vielinis šepetys • Dräsu birste • Traathari • Четка телена • Cetka sa PVC držskom • Cetka • Συρμάτινη βούρτσα • Cepillo de alambre • Spazzola metallica • Escova de arame • Brosse métallique

Ref.	Ø1[mm]	Ø2[mm]		EAN	
57H592	125	20	16, 12 mm	5902062575920	6/60
57H593	150	32	25, 22, 20, 16, 12 mm	5902062575937	6/30
57H594	200	32	25, 22, 20, 16, 12 mm	5902062575944	6/24

GRAPHITE

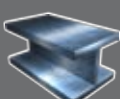
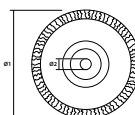

Szczotka druciana

Wirebrush • Drahtbürste • Щетка проволочная • Щетка по металлу • Spidkefe • Perie metal • Drátěný kartáč • Keďa drótená univerzálna • Zična krtača • Vielinis šepetys • Dräsu birste • Traathari • Четка телена • Cetka sa PVC držskom • Cetka • Συρμάτινη βούρτσα • Cepillo de alambre • Spazzola metallica • Escova de arame • Brosse métallique

Ref.	Ø1[mm]	Ø2[mm]	EAN	
57H599	50	6,1	5902062575999	12/120
57H600	75	6,1	5902062576002	12/120

Szczotka druciana

Wire brush - Drahtbürste - Щетка проволочная - Щітка по металу - Spidkefe - Perie metal - Drátěný kartáč - Kefa drótená univerzálna - Zičnákrtáča - Vielinis šepetys - Drásu birste - Traathari - Черкателена - Cetkasa PVC drskom - Cetka - Συρματίνη βούρτσα - Cepillo de alambre - Spazzola metallica - Escova de arame - Brosse métallique

Ref.	Ø1 [mm]	Ø2 [mm]	EAN	
57H601	50	6,25	5902062576019	12/120
57H602	75	6,25	5902062576026	12/120

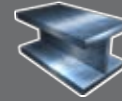
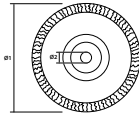





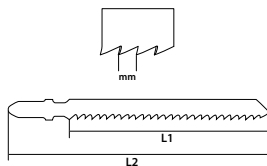

Brzeszczyty do wyrzynarki

Jigsaw blades - Sägeblätter für Schweißsäge - Полотно для лобзика - Полотно пильне до лобзика - Fűrészlapok szűrfűrészhez - Pânze de ferăstrău de decupat - Pílové listy pro listovou pilu - Listy do priamočiarej pílkы - Listy za vrbodno žago - Pjåklivkål siæurapjåkliv - Finierzåga asmenj - Tikkæe terrad - Листове за ажурна дървообработваща машина - Listovi pile za vrbodnu pilu - Sečiva za ručnu testeru - Приволажес оујас - Hojas para sierra de calar - Láminas p. Máquina de entallar - Lames descie pour scie sauteuse

GRAPHITE



Ref.	L1 [mm]	L2 [mm]	TPI/mm						EAN			
57H759	75	100	8/3.0	T	x	x		6-30	5	CV	5902062577597	1/20
57H760	75	100	10/2.5	T	x	x		4-30	5	CV	5902062577603	1/20
57H761	75	100	6/4.0	T	x	x		6-60	5	CV	5902062577610	1/20
57H762	75	100	6/4.0	T	x			8-60	5	CV	5902062577627	1/20
57H763	75	100	6/4.0	T	x			8-60	5	CV	5902062577634	1/20
57H764	75	100	8/3.0	T	x			5-60	5	CV	5902062577641	1/20
57H765	50	75	12/2.0	T	x	x		2-15	5	CV	5902062577658	1/20
57H766	50	75	12/2.0	T	x	x		4-20	5	CV	5902062577665	1/20
57H767	50	75	21/1.2	T			x	1.5-3.0	5	HSS	5902062577672	1/20
57H768	50	75	21/1.2	T			x	1.5-3.0	5	Bi-metal	5902062577689	1/20
57H769	75	100	10/2.5	T	x			4-30	5	CV	5902062577696	1/20
57H770	75	100	12/2.0	T	x			3-60	5	CV	5902062577702	1/20
57H771	105	130	10/14	T	x		x	3-100	5	Bi-metal	5902062577719	1/20
57H772	75	100	10/2.5	U	x	x		4-30	5	CV	5902062577726	1/20
57H773	75	100	6/4.0	U	x	x		6-60	5	CV	5902062577733	1/20
57H774	75	100	6/4.0	U	x			8-60	5	CV	5902062577740	1/20
57H775	75	100	6/4.0	U	x			8-60	5	CV	5902062577757	1/20
57H776	75	100	8/3.0	U	x			5-60	5	CV	5902062577764	1/20
57H777	50	75	12/2.0	U	x	x		2-15	5	CV	5902062577771	1/20
57H778	50	75	12/2.0	U	x	x		4-20	5	CV	5902062577788	1/20
57H779	50	75	21/1.2	U			x	1.5-3.0	5	HSS	5902062577795	1/20
57H780	50	75	21/1.2	U			x	1.5-3.0	5	Bi-metal	5902062577801	1/20
57H781	75	100	10/2.5	U	x			4-30	5	CV	5902062577818	1/20
57H782	75	100	12/2.0	U	x			3-60	5	CV	5902062577825	1/20
57H783	105	130	10/14	U	x		x	3-100	5	Bi-metal	5902062577832	1/20



GRAPHITE

Jigsaw blades • Sägeblätter für Schweißsäge • Полотна для лобзика • Полотно пильне до лобзика • Fűrészlapok szűrőfűrészhez • Pánze de ferăstrău de decupat • Pilové listy pro listovou pilu • Listy do priamočiarej pilky • Listi za vobodno žago • Pjőkliukai siaurapjőkliui • Finierząga asmeni • Tikksae terad • Листове за ажурна дървообработваща машина • Listovi pile za vobodnu pilu • Sečiva za ručnu testeru • Приονόλαμες σέγας • Hojas para sierra de calar • Lame per seghetto alternativo • Láminas p. Máquina de entalhar • Lames de scie pour scie sauteuse

Brzeczoty do wyrzynarki

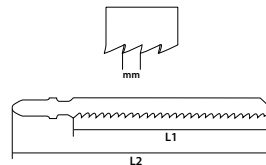

Ref.	L1 [mm]	L2 [mm]	TPI/mm	T	X	X	X	INOX			EAN		
57H760-25	75	100	10/2.5	T	x	x			4-30	25	CV	5902062577603	1/20
57H761-25	75	100	6/4.0	T	x	x			6-60	25	CV	5902062577610	1/20
57H762-25	75	100	6/4.0	T	x				8-60	25	CV	5902062577627	1/20
57H764-25	75	100	8/3.0	T	x				5-60	25	CV	5902062577641	1/20
57H767-25	50	75	21/1.2	T				x	1.5-3.0	25	HSS	5902062577672	1/20
57H770-25	75	100	12/2.0	T	x				3-60	25	CV	5902062577702	1/20

GRAPHITE

Jigsaw blades • Sägeblätter für Schweißsäge • Полотна для лобзика • Полотно пильне до лобзика • Fűrészlapok szűrőfűrészhez • Pánze de ferăstrău de decupat • Pilové listy pro listovou pilu • Listy do priamočiarej pilky • Listi za vobodno žago • Pjőkliukai siaurapjőkliui • Finierząga asmeni • Tikksae terad • Листове за ажурна дървообработваща машина • Listovi pile za vobodnu pilu • Sečiva za ručnu testeru • Приονόλαμες σέγας • Hojas para sierra de calar • Lame per seghetto alternativo • Láminas p. Máquina de entalhar • Lames de scie pour scie sauteuse

Brzeczoty do wyrzynarki

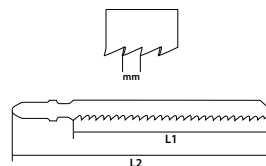

Ref.	L1 [mm]	L2 [mm]	TPI/mm	T	X	X	X	INOX	max. H [mm]		EAN	
57H754	75	100	6/4.0	T	x	x			6-30	6	5902062577542	0/40
	75	100	6/4.0	T	x			4-30	CV			
	50	75	6/4.0	T	x	x		6-60	CV			
	50	75	21/1.2	T			x	8-60	HSS			
	75	100	10/2.5	T	x			8-60	CV			
	50	75	21/1.2	T			x	5-60	Bi-metal			

GRAPHITE

Jigsaw blades • Sägeblätter für Schweißsäge • Полотна для лобзика • Полотно пильне до лобзика • Fűrészlapok szűrőfűrészhez • Pánze de ferăstrău de decupat • Pilové listy pro listovou pilu • Listy do priamočiarej pilky • Listi za vobodno žago • Pjőkliukai siaurapjőkliui • Finierząga asmeni • Tikksae terad • Листове за ажурна дървообработваща машина • Listovi pile za vobodnu pilu • Sečiva za ručnu testeru • Приονόλαμες σέγας • Hojas para sierra de calar • Lame per seghetto alternativo • Láminas p. Máquina de entalhar • Lames de scie pour scie sauteuse

Brzeczoty do wyrzynarki

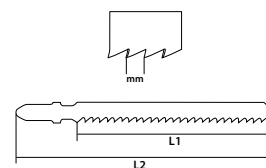

Ref.	L1 [mm]	L2 [mm]	TPI/mm	T	X	X	X	INOX	max. H [mm]		EAN	
57H755	75	100	6/4.0	T	x	x			6-30	10	5902062577559	0/40
	75	100	6/4.0	T	x			4-30	CV			
	50	75	6/4.0	T	x	x		6-60	CV			
	50	75	21/1.2	T			x	8-60	HSS			
	75	100	8/3.0	T	x	x		8-60	CV			
	75	100	10/2.5	T	x			5-60	CV			
50	75	21/1.2	T			x	5-60	Bi-metal				

Brzeczscoty bagnetowe

Sabre saw blade • Bajonett-Sägenblatt • Полотна • Полотна пильні з точним зубом • Kardfűrészlapok • Panze baioneta • Mečové pilové listy • Mečové pilové listy • Bajonetni žagani listi • Bimetaliniai pjūkliukai • Asmens zobenzāģim • Tāķ-saelehed • Сменными лентами за трион • Bajonet listivoy pile • Oštrice noža • Πριονόλαμες • Hojas de sable • Lame per seghetto alternativo • Láminas • Lames de scie à baïonnette

GRAPHITE

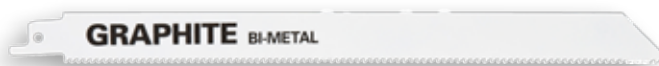

Ref.	L1 [mm]	L2 [mm]	H [mm]	W [mm]	TPI/mm		EAN	
57H947	230	250	20	0.9	10/2.5	5	5902062579478	5/50
57H948	280	300	20	0.9	14/1.8	5	5902062579485	5/50
57H949	80	100	20	0.9	14/1.8	5	5902062579492	5/50
57H950	130	150	20	0.9	10-14/2.5-1.8	5	5902062579508	5/50
57H951	130	150	20	0.9	14/1.8	5	5902062579515	5/50
57H952	205	225	20	0.9	14/1.8	5	5902062579522	5/50
57H953	205	225	20	0.9	18/1.4	5	5902062579539	5/50
57H954	205	225	20	0.9	6/4.0	5	5902062579546	5/50

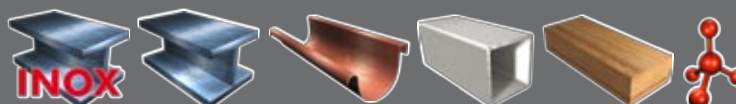
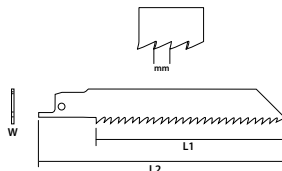

Otwornica

Compass saw • Lochsäge • Ножовка • Фреза • Körkivágó • Ferăstrău pentru găuri • Dėrovka • Dierovacia pila • Luknjarica • Vienarankis pjūklas • Rokzāģis • Augusaag • Тесен трион • Nareznica • Ručna testera za pravljenje otvora • Πριόνι • Sierra de corona • Segă a tazza • Serra para recorte • Scie à guichet

GRAPHITE

Ref.	Ø [mm]	H [mm]	MAX.							EAN	
57H900	16	38	3000	2250	550	275	730	825	5902062579003	6/120	
57H902	19	38	3000	2250	460	230	600	690	5902062579027	6/120	
57H904	20	38	3000	2250	425	210	560	635	5902062579041	6/120	
57H906	22	38	3000	2250	390	195	520	585	5902062579065	6/120	
57H908	25	38	2700	2000	350	175	470	525	5902062579089	6/120	
57H910	29	38	2700	2000	300	150	400	450	5902062579102	6/120	
57H912	32	38	2400	1800	275	140	380	410	5902062579126	6/120	
57H914	35	38	2400	1800	250	125	330	375	5902062579140	6/120	
57H916	38	38	2400	1800	240	120	315	360	5902062579164	6/120	
57H918	40	38	2100	1500	220	110	290	330	5902062579188	6/120	
57H920	46	38	2100	1500	195	95	260	295	5902062579201	6/120	
57H922	51	38	2000	1500	170	85	230	255	5902062579225	6/120	
57H924	57	38	2000	1500	150	75	200	225	5902062579249	6/120	
57H926	64	38	1800	1350	135	65	180	205	5902062579263	6/60	
57H928	67	38	1800	1350	125	60	160	185	5902062579287	6/60	
57H930	73	38	1800	1350	120	60	160	180	5902062579300	6/60	
57H932	83	38	1500	1100	105	40	140	155	5902062579324	6/60	
57H934	95	38	1200	900	95	40	120	140	5902062579348	6/30	
57H936	105	38	1000	750	80	40	110	120	5902062579362	6/30	

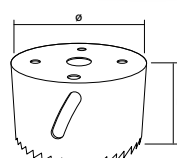

Adapter do otwornic

Hole cutter adaptor • Adapter für Betonstichsägen • Переходник для коронок по бетону • Adapter do vikuřalnice po betonu • Adapter fűrőkalapácshoz • Adaptor p/u sřredelirea sondelor • Adaptėr do dėrovek na beton • Stopka SDS max • Adapter SDS • Adapteris karūnai, betonui greiži • Adapters Křoņurbim • Augulōikuri adapter • SDS Max Адaptor • SDS max adapter • SDS adapter • Αντάρτορας για λοτρκοκρωνα για μπeton • Adaptador de sierras de corona perforadoras de hormigón • Adattatore per seghe da traforo per calcestruzzo • Adaptador p. serras para recorte p. betão • Adaptateur de scie à guichet pour béton

GRAPHITE

Ref.	Ø [mm]	info	EAN	
57H938	14-30	adapter	5902062579386	12/120
57H940	32-105	adapter	5902062579409	12/60
57H944	6,35	wiertło	5902062579447	24/144

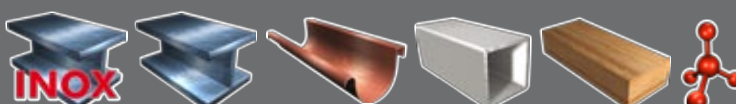

GRAPHITE

Papier ścierny

Sanding paper • Schleifpapier • Бумага наждачная • Папір наждачний • Csiszolópapír • Hirtie de șmirghel • Brusný papír • Brusny papier • Brusni papir • Šlifavimo popierius • Šlīplapa • Lītvapaber • Шкурка • Brusni papir • Brusni papir • Λειαντικό χαρτί • Lija • Carta abrasiva • Folha de lixa • Papier abrasif

59G335



NEW

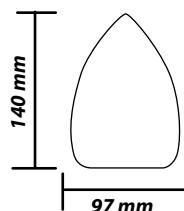

Ref.			EAN	
57H820	K40	5	5902062578204	1/30
57H822	K60	5	5902062578228	1/30
57H824	K80	5	5902062578242	1/30
57H826	K120	5	5902062578266	1/30
57H828	K150	5	5902062578280	1/30

GRAPHITE

Krażki ścierne

Abrasive discs • Schleifscheibe • Шлифовальные круги • Круги шлифовальні • Csiszolókorongok • Discuri abrazive • Brusné kroužky • Brúsné kotúče • Brusne plošče • Šlifavimo diskellai • Šlīpšanas aplī • Lihvrongad • Абразивни дискове • Brusni kolūtīti • Diskovi za brušenje • Δίσκοι λείανσης • Hoja de lija circular • Dischi abrasivi • Discos abrasivos • Roulette abrasive

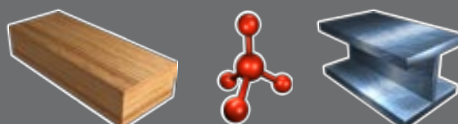
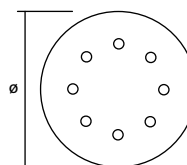

Ref.		Ø[mm]		EAN	
57H784	K40	125	3	5902062577849	1/30
57H785	K60	125	3	5902062577856	1/30
57H786	K80	125	3	5902062577863	1/30
57H787	K100	125	3	5902062577870	1/30
57H788	K120	125	3	5902062577887	1/30

GRAPHITE

Krażki ścierne

Abrasive discs • Schleifscheibe • Шлифовальные круги • Круги шлифовальні • Csiszolókorongok • Discuri abrazive • Brusné kroužky • Brúsné kotúče • Brusne plošče • Šlifavimo diskellai • Šlīpšanas aplī • Lihvrongad • Абразивни дискове • Brusni kolūtīti • Diskovi za brušenje • Δίσκοι λείανσης • Hoja de lija circular • Dischi abrasivi • Discos abrasivos • Roulette abrasive

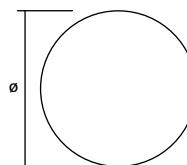
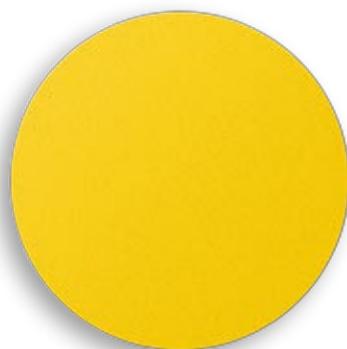

Ref.		Ø[mm]		EAN	
57H806	K80	225	5	5902062578068	0/5
57H808	K120	225	5	5902062578082	0/5
57H810	K180	225	5	5902062578105	0/5

Siatka ścierna

Abrasive grid • Schleifgitter • Сетка шлифовальная • Сетка абразивная • Csizsolórács • Pílašá abrázivná • Brusná mřížka • Mriežka brúsná • Vodobrusní papír • Šlifavimo tinklėtis • Abrazīvais siets • Lihvimisvõrk • Шкурка • Vodobrusni papir • Vodobrusni papir • Λειαντικό πλέγμα • Malla de lijado • Rete abrasiva • Rede abrasiva • Grille abrasive

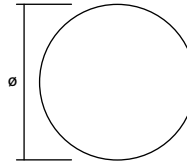

Ref.		Ø[mm]	EAN	
57H812	K40	225	5902062578129	10/300
57H814	K80	225	5902062578143	10/300
57H816	K120	225	5902062578167	10/300
57H818	K180	225	5902062578181	10/300



GRAPHITE

Pas bezkońcowy

Sanding belt • Riemen endless • Лента абразивная бесконечная • Стричка наждачна безкінечна • Csizsolóvászón végtelenített • Bandă de șlefuit • Pískový brusný pás • Brúsný pás • Neskončni trak • Popierine šlifavimo juosta • Sliplenta • Lihvimislint • Шкурка • Brusna traka • Brusna traka • Λειαντική ταινία • Banda lijadora • Cinghia ad anello • Cinto sem fim • Ceinture sans fin

Ref.	W [mm]	L [mm]		EAN	
57H799	K40	75	533	2 5902062577993	1/10
57H800	K60	75	533	2 5902062578006	1/10
57H801	K80	75	533	2 5902062578013	1/10
57H802	K100	75	533	2 5902062578020	1/10
57H803	K120	75	533	2 5902062578037	1/10

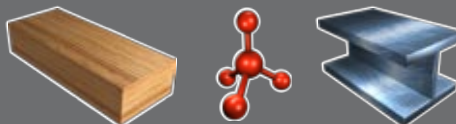
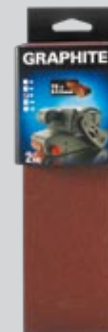
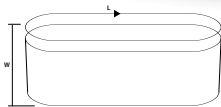

GRAPHITE

Tarcza elastyczna

Elastic disc • Flexible Scheibe • Эластичный диск • Диск эластичный • Elastikus tárcsa • Disc elastic • Elastický kotouč • Elastický kotúč • Elastická plošča • Elastinis diskas • Elastigais disks • Elastne kets • Эластичен диск • Elastinė ploča • Elastinė ploča • Ελαστικός δίσκος • Disco elástico • Disco elastico • Disco elástico • Disque flexible

Ref.	Ø[mm]	EAN	
55H770	180	5902062687708	1/10

NEW

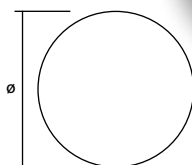

GRAPHITE

GRAPHITE

Futro polerskie

Polishing buff • Pflanzstoff • Шкурка полировочная • Хуртийний полірувальний круг • Polírozó szőrmé • Blana de lustruit • Leštící kožovina
 • Leštící kotčič • Polirno krzno • Poliravimo kailis • Polišanas sudėklis • Polierimistatursnahk • Кожа за полиране • Krzno za poliranje
 • Krzno za poliranjeΓούνα στίλβωσης • Caperuzas de lana de oveja • Cuffia per lucidatura • Pele para polir • Fourrure de polissage



59G242



NEW

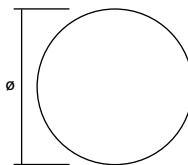

Ref.	Ø[mm]	EAN	Box
55H771	180	5902062687715	1/10

GRAPHITE

Uchwyt magnetyczny

Bit holder quick release • Magnetaufnahme • Держатель магнитный • Патрон магнітний • Mágneses befogó •
 Suport biti magnetic • Magnetický držák • Magnetické sklúčovadlo • Magnetno vpenjalo • Magnetinis griebtuvas
 • Magnētiskais turētājs • Magnetpadrun • Магнитен държач • Magnetna hvataljka • Magnetna drška • Υπόδοχη
 μαγνητική • Mandril de sujeción magnético • Imprignatura magnetica • Suporte magnético • Manche magnétique

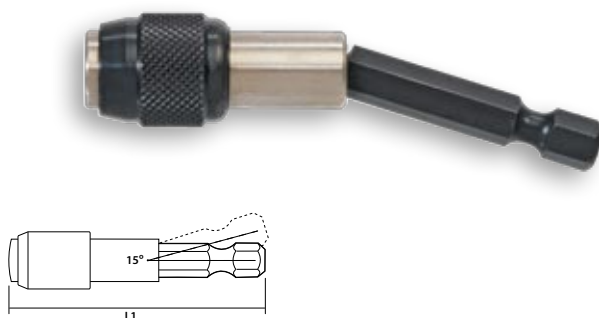

Ref.	L [mm]	EAN	Box
55H995	65	5902062689955	1/75



GRAPHITE

Uchwyt magnetyczny

Bit holder quick release • Magnetaufnahme • Держатель магнитный • Патрон магнітний • Mágneses befogó •
 Suport biti magnetic • Magnetický držák • Magnetické sklúčovadlo • Magnetno vpenjalo • Magnetinis griebtuvas
 • Magnētiskais turētājs • Magnetpadrun • Магнитен държач • Magnetna hvataljka • Magnetna drška • Υπόδοχη
 μαγνητική • Mandril de sujeción magnético • Imprignatura magnetica • Suporte magnético • Manche magnétique

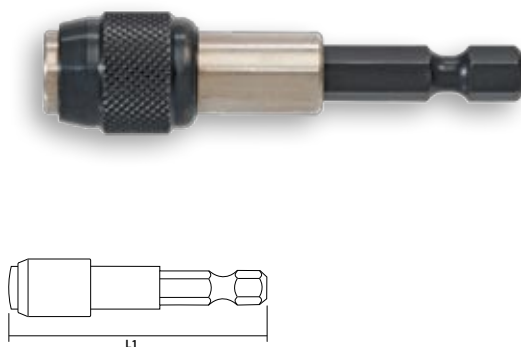

Ref.	L [mm]	EAN	Box
57H995	60	5902062579959	10/200



Nasadki magnetyczne

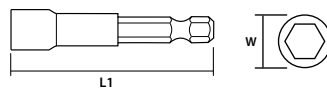

Magnetic sockets - Aufsätze magnetisch - Наконечники магнитные - Патрони магнітні - Magnéses betételek - Vrätarå magnetiska - Magnetické nástavce - Magnetické nástavce - Magnētini nasadni kļūvēji - Magnētiskie uzgali - Magnetsokki - Магнітні насадки - Magnetski nasadni nastavi - Magnetne kapice - Μαγνητική υποδοχή - Vaso magnético - Inzerti magnetici - Bocais magnéticos - Douilles magnétiques

Ref.	L [mm]	W [mm]	EAN	
57H991	65	6	5902062579911	10/200
57H992	65	8	5902062579928	10/200
57H993	65	10	5902062579935	10/200
57H994	65	13	5902062579942	10/200



Końcówki wkrętakowe

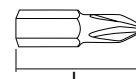

Bit set - Schraubendreheraufsätze - Наконечники отверточные - Набір жал - Behajtótűske phillips - Canulă tip „Phillips” - Bity do śroubováků - Bit Phillips PH - Vijačni nastavki - Antgaliai atsuktuvams Phillips - Skrūvgrieža uzgali PH - Ristpeatsik - Накрайници - Bic - Bic - Μύρες εγκότης τύπου phillips - Puntas destornilladoras - Punte per cacciaviti - Ponteiros de chave de fenda - Embouts de tournevis

Ref.		L [mm]		EAN	
57H960	PH 1	25	2	5902062579607	10/360
57H961	PH 2	25	2	5902062579614	10/360
57H962	PH 3	25	2	5902062579621	10/360
57H963	PZ 1	25	2	5902062579638	10/360
57H964	PZ 2	25	2	5902062579645	10/360
57H965	PZ 3	25	2	5902062579652	10/360
57H966	HEX 2,5	25	2	5902062579669	10/360
57H967	HEX 3	25	2	5902062579676	10/360
57H968	HEX 4	25	2	5902062579683	10/360
57H969	HEX 5	25	2	5902062579690	10/360
57H970	HEX 6	25	2	5902062579706	10/360
57H971	TX 10	25	2	5902062579713	10/360
57H972	TX 15	25	2	5902062579720	10/360
57H973	TX 20	25	2	5902062579737	10/360
57H974	TX 25	25	2	5902062579744	10/360
57H975	TX 27	25	2	5902062579751	10/360
57H976	TX 30	25	2	5902062579768	10/360
57H977	TX 40	25	2	5902062579775	10/360



Końcówki wkrętakowe

Bit set - Schraubendreheraufsätze - Наконечники отверточные - Набір жал - Behajtótűske phillips - Canulă tip „Phillips” - Bity do śroubováků - Bit Phillips PH - Vijačni nastavki - Antgaliai atsuktuvams Phillips - Skrūvgrieža uzgali PH - Ristpeatsik - Накрайници - Bic - Bic - Μύρες εγκότης τύπου phillips - Puntas destornilladoras - Punte per cacciaviti - Ponteiros de chave de fenda - Embouts de tournevis

Ref.		L [mm]		EAN	
57H978	PH 1	50	1	5902062579782	10/360
57H979	PH 2	50	1	5902062579799	10/360
57H980	PH 3	50	1	5902062579805	10/360
57H981	PZ 1	50	1	5902062579812	10/360
57H982	PZ 2	50	1	5902062579829	10/360
57H983	PZ 3	50	1	5902062579836	10/360
57H984	TX 10	50	1	5902062579843	10/360
57H985	TX 15	50	1	5902062579850	10/360
57H986	TX 20	50	1	5902062579867	10/360
57H987	TX 25	50	1	5902062579874	10/360
57H988	TX 27	50	1	5902062579881	10/360
57H989	TX 30	50	1	5902062579898	10/360
57H990	TX 40	50	1	5902062579904	10/360



GRAPHITE

GRAPHITE

GRAPHITE